

EXPLODED DRAWING A

Model No. PFTL97718.3 R0518A

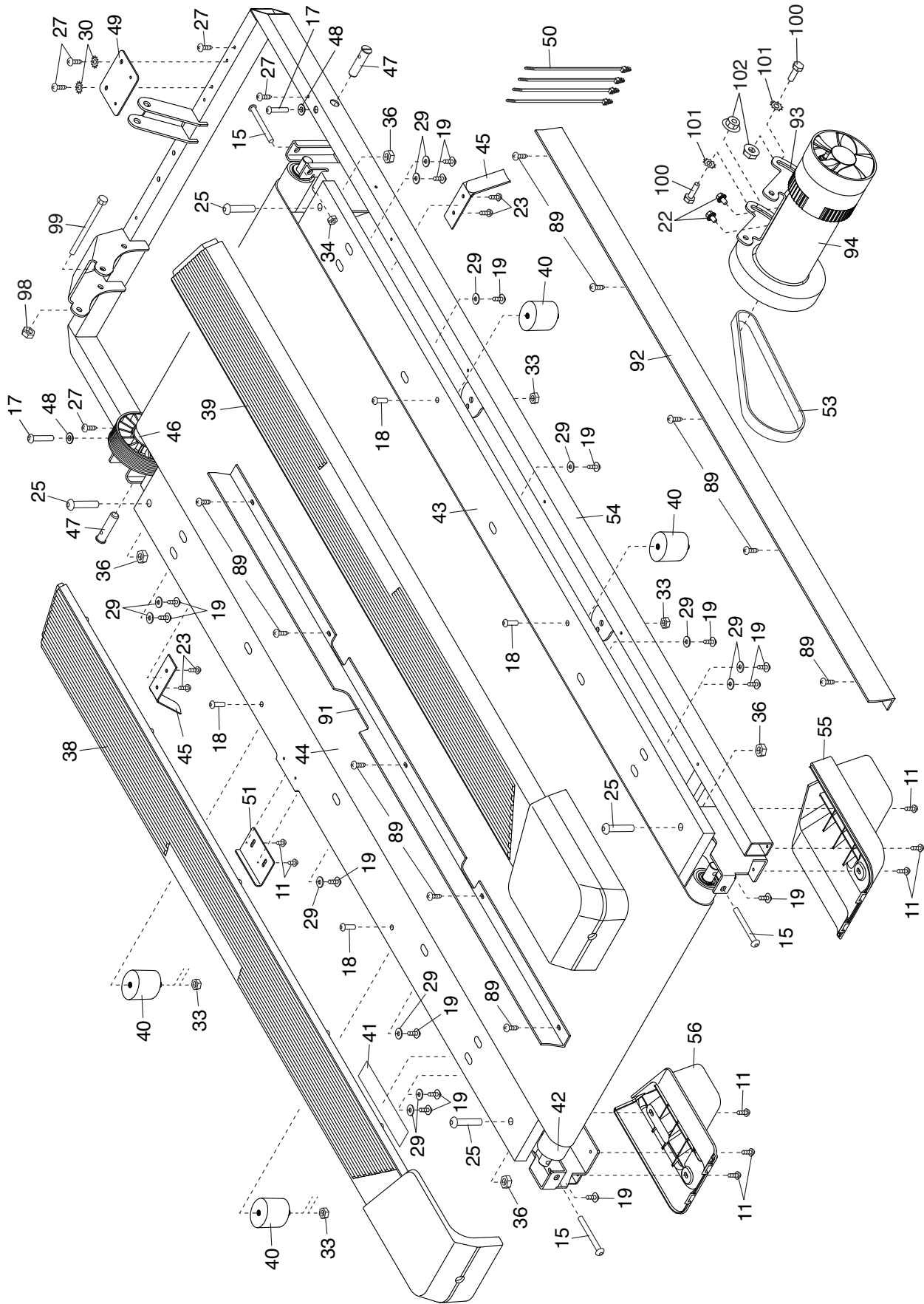

EXPLODED DRAWING B

Model No. PFTL97718.3 R0518A

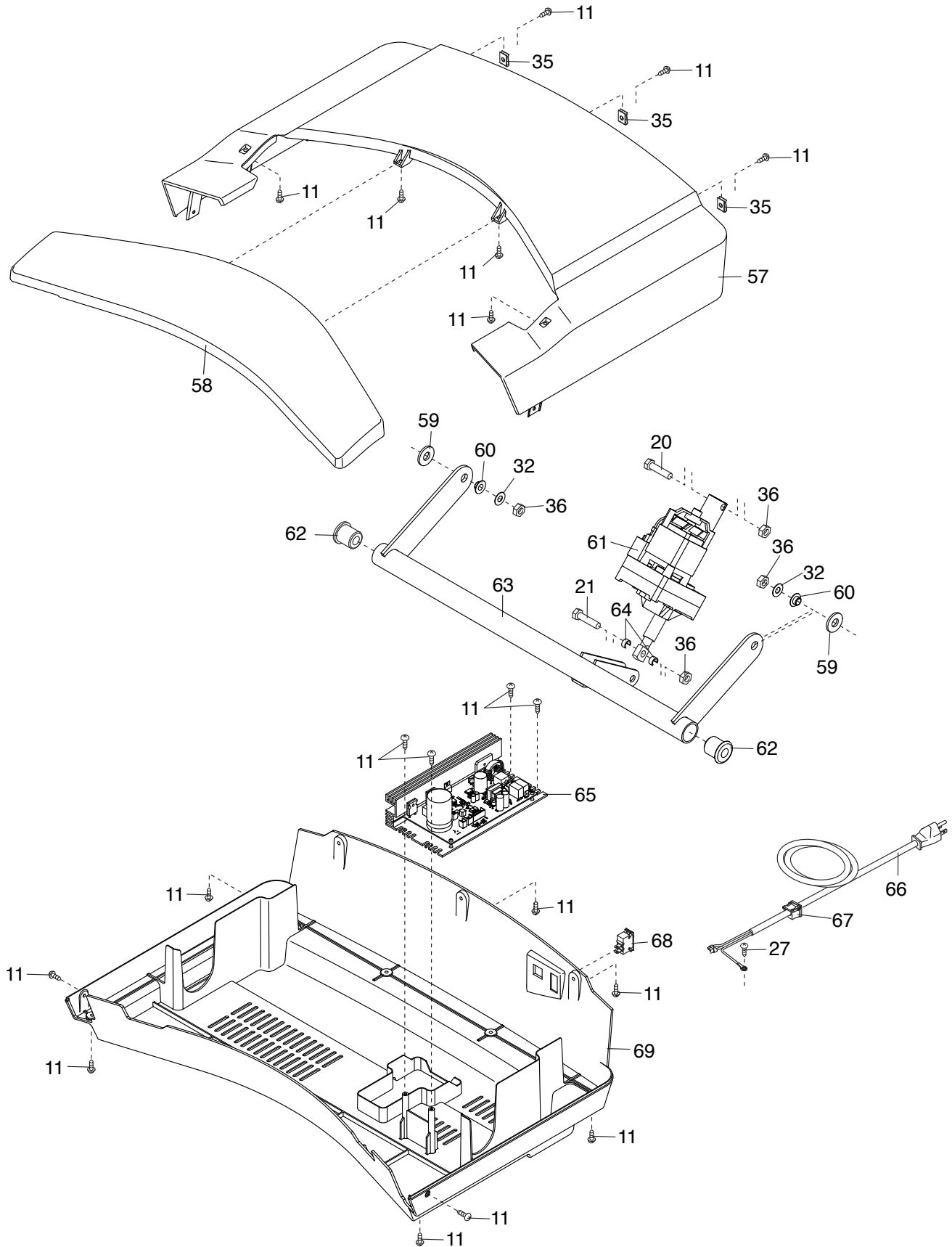

EXPLODED DRAWING C

Model No. PFTL97718.3 R0518A

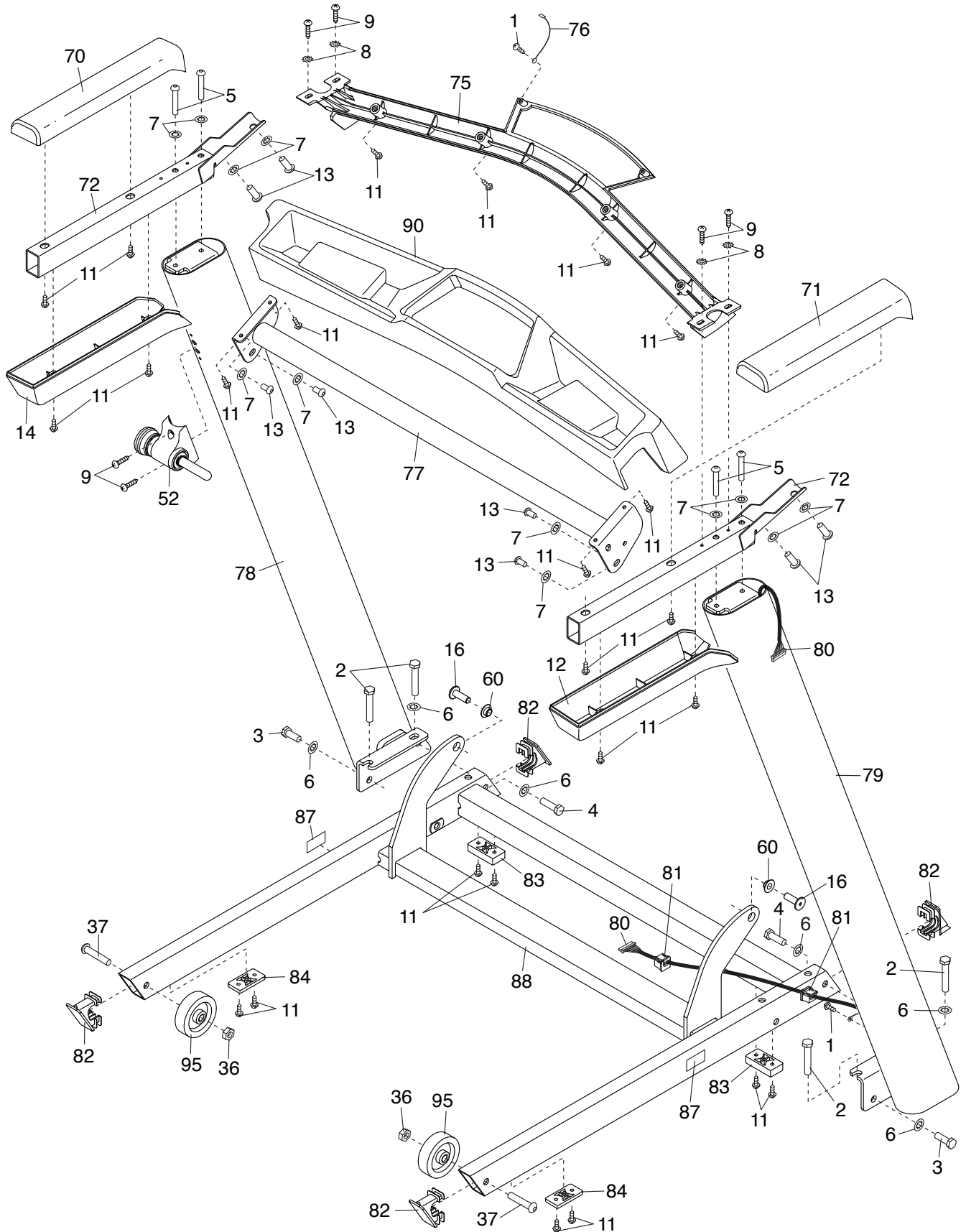

EXPLODED DRAWING D

Model No. PFTL97718.3 R0518A

