

# EXPLODED DRAWING A—Model No. PFTL97908.0

R0808A

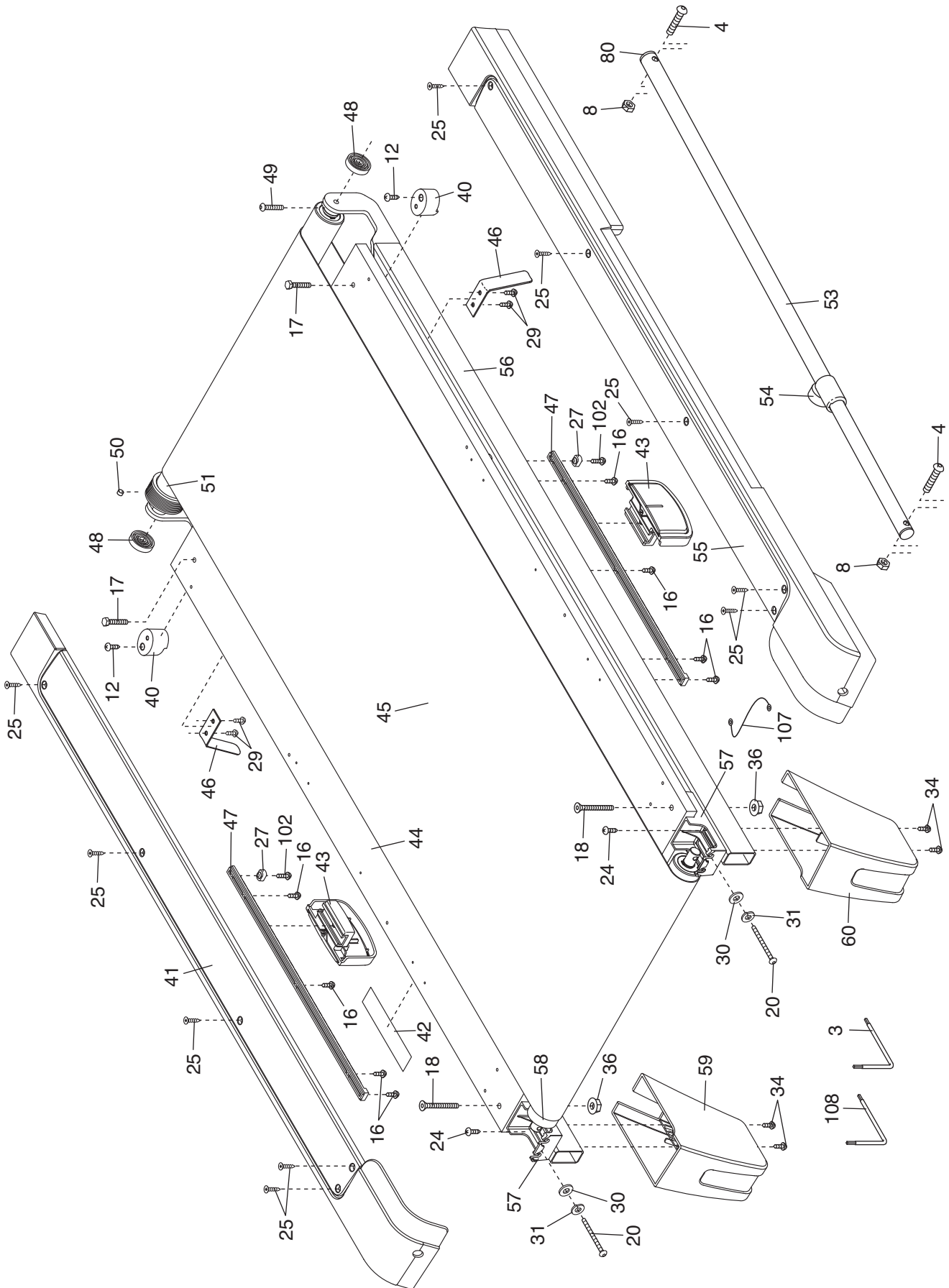

# EXPLODED DRAWING B—Model No. PFTL97908.0

R0808A

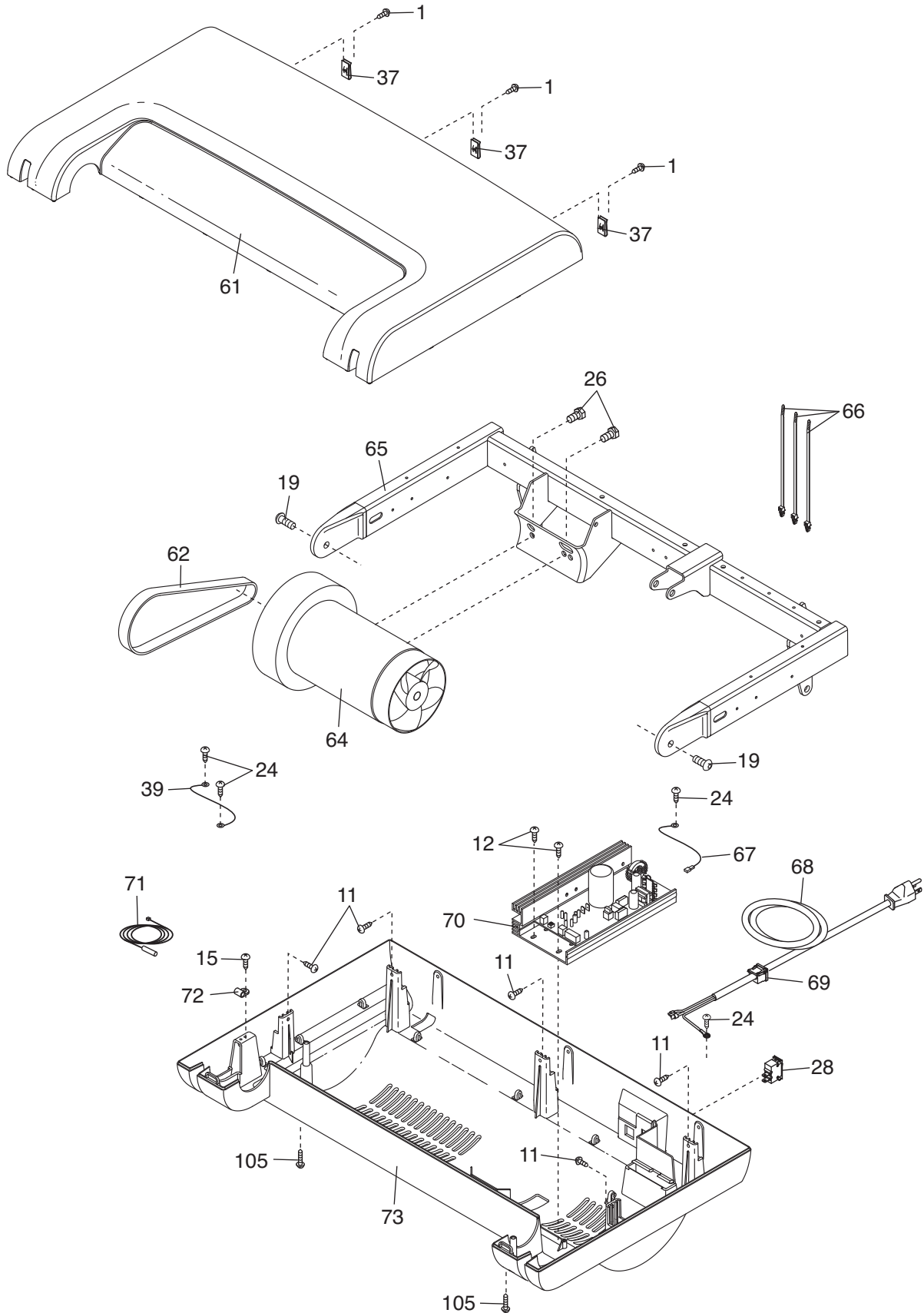

# EXPLODED DRAWING C—Model No. PFTL97908.0

R0808A

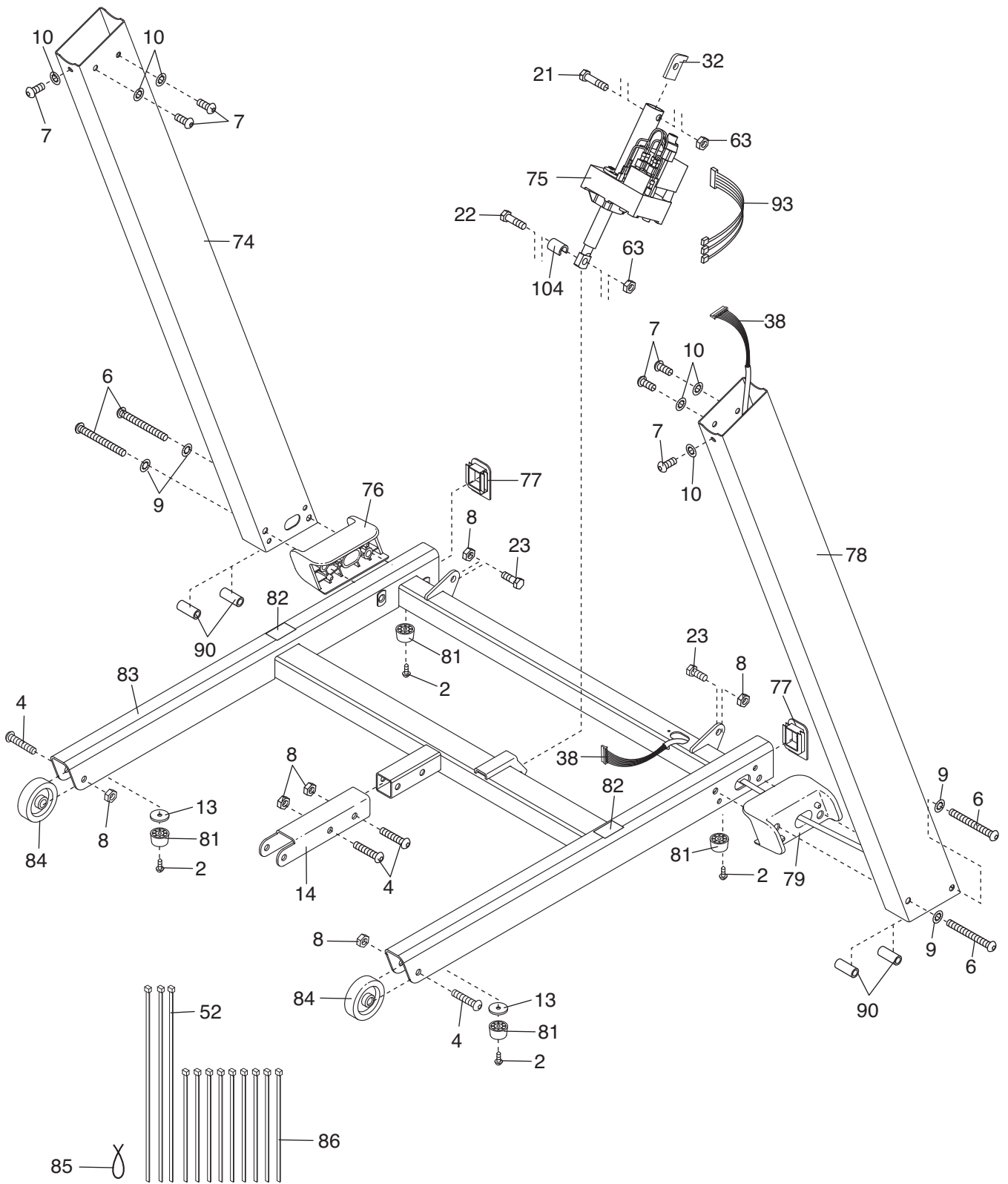

# EXPLODED DRAWING D—Model No. PFTL97908.0

R0808A

