

# EXPLODED DRAWING A

Model No. PFTL98015.1 R1115A

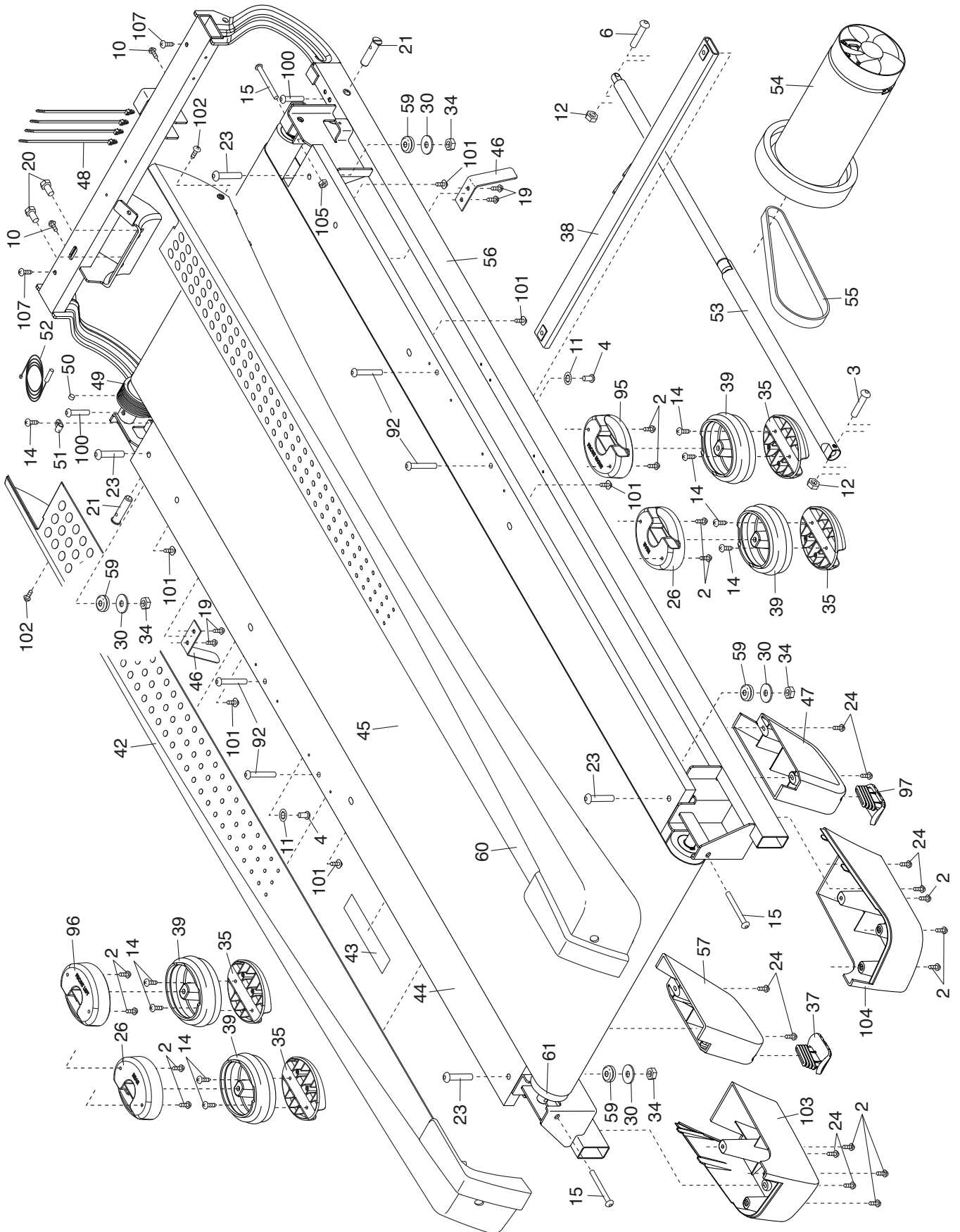

# EXPLODED DRAWING B

Model No. PFTL98015.1 R1115A

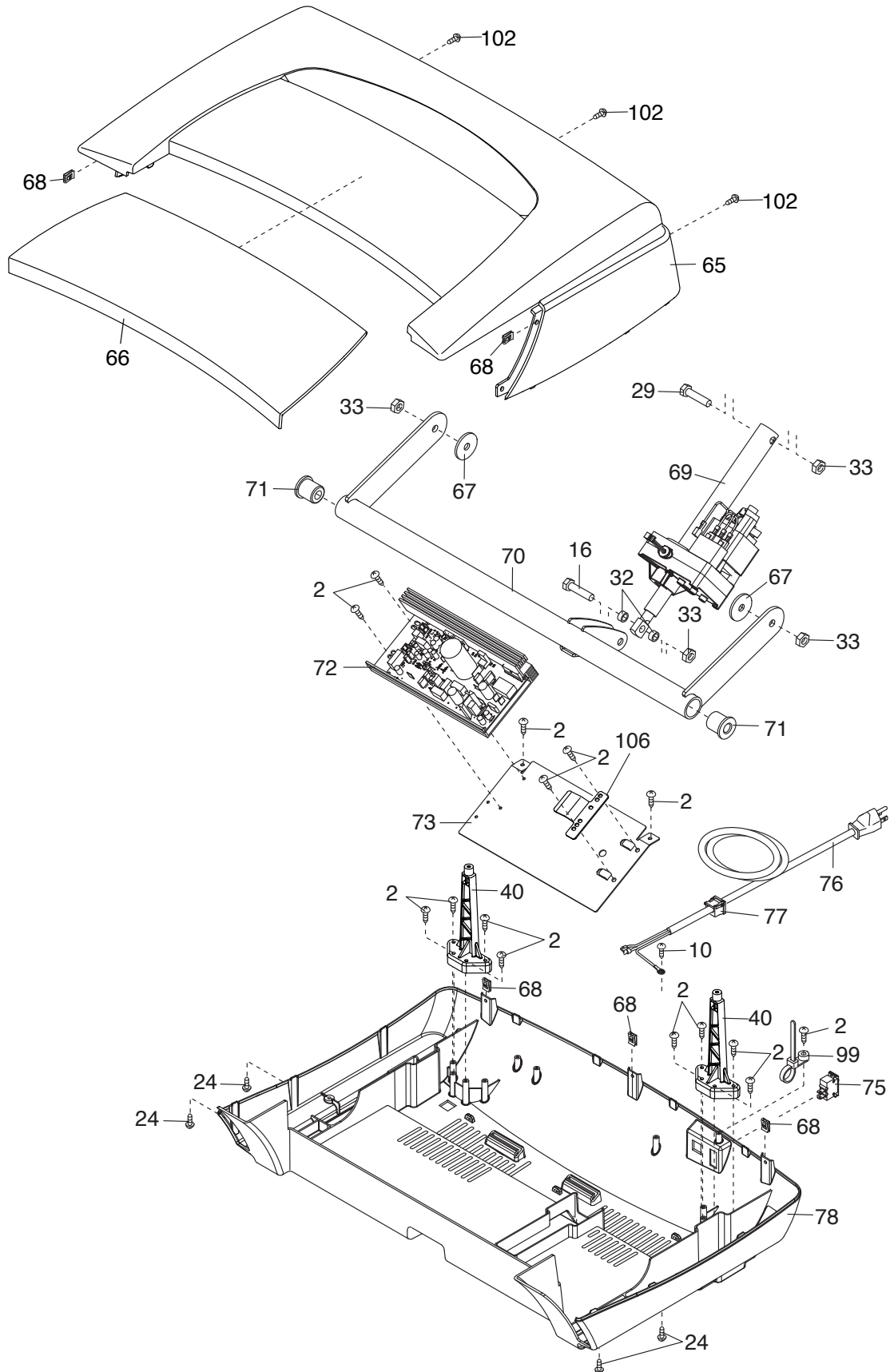



# EXPLODED DRAWING D

Model No. PFTL98015.1 R1115A

