

EXPLODED DRAWING A

Model No. PFTL98115.0 R1215A

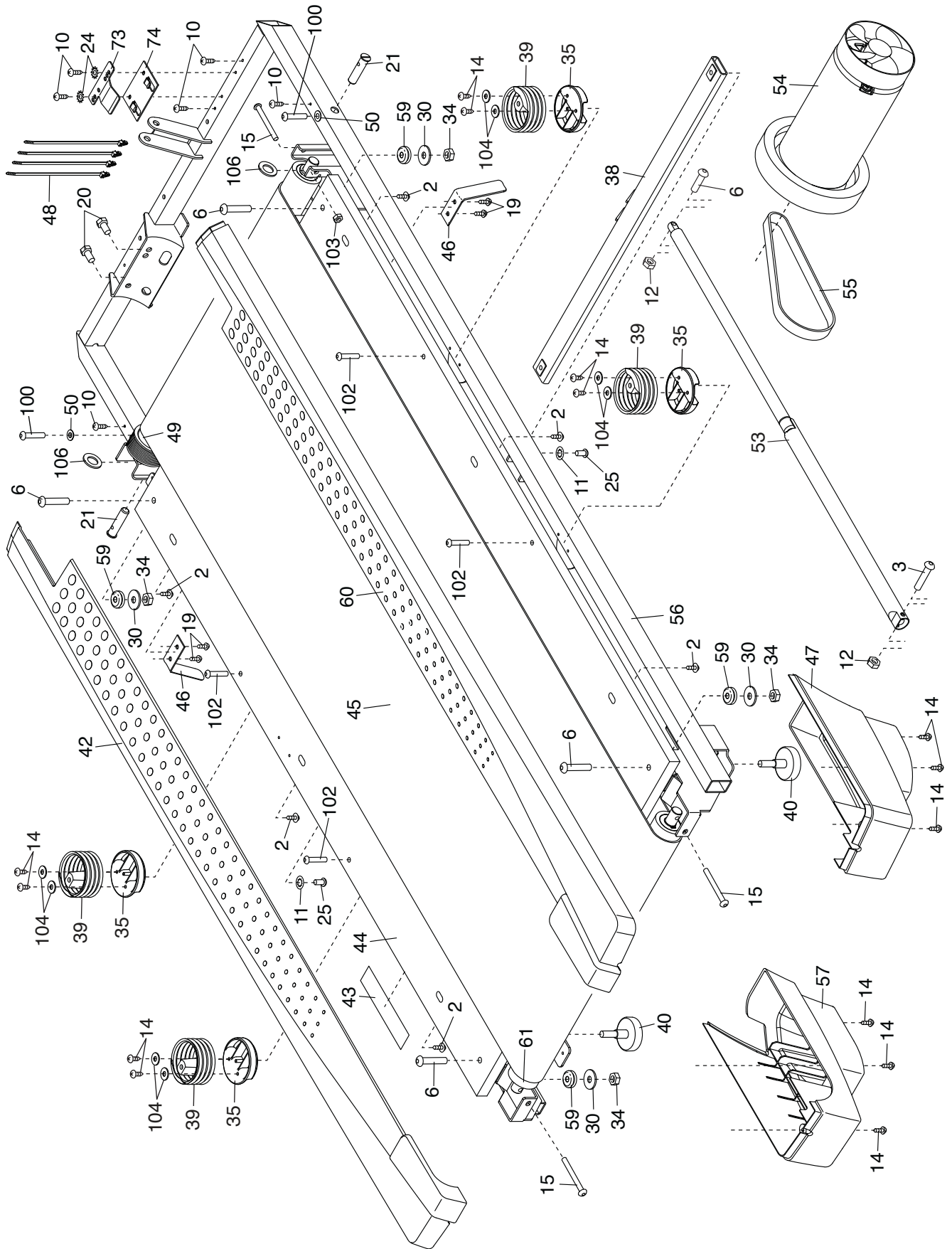

EXPLODED DRAWING B

Model No. PFTL98115.0 R1215A

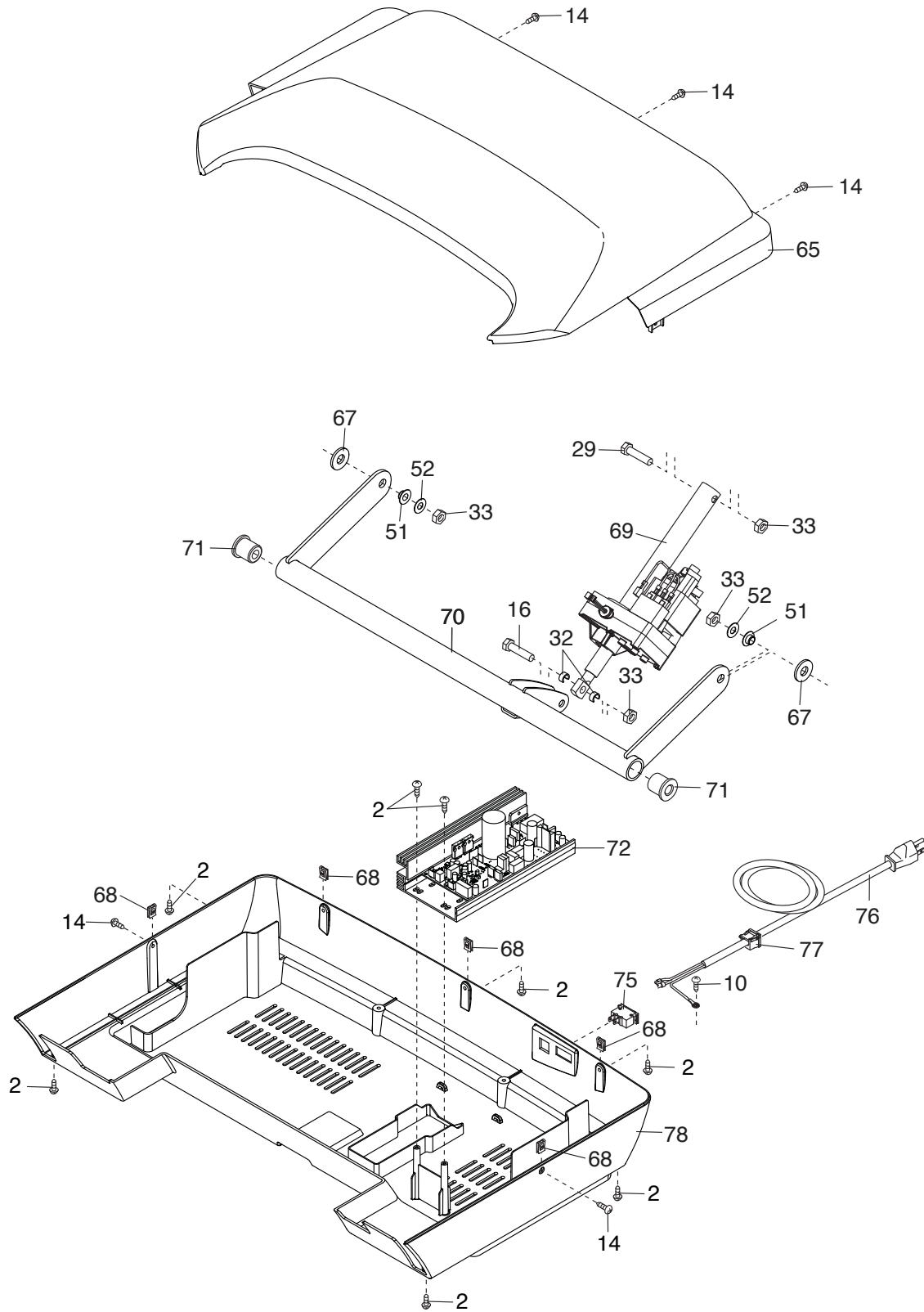

EXPLODED DRAWING C

Model No. PFTL98115.0 R1215A

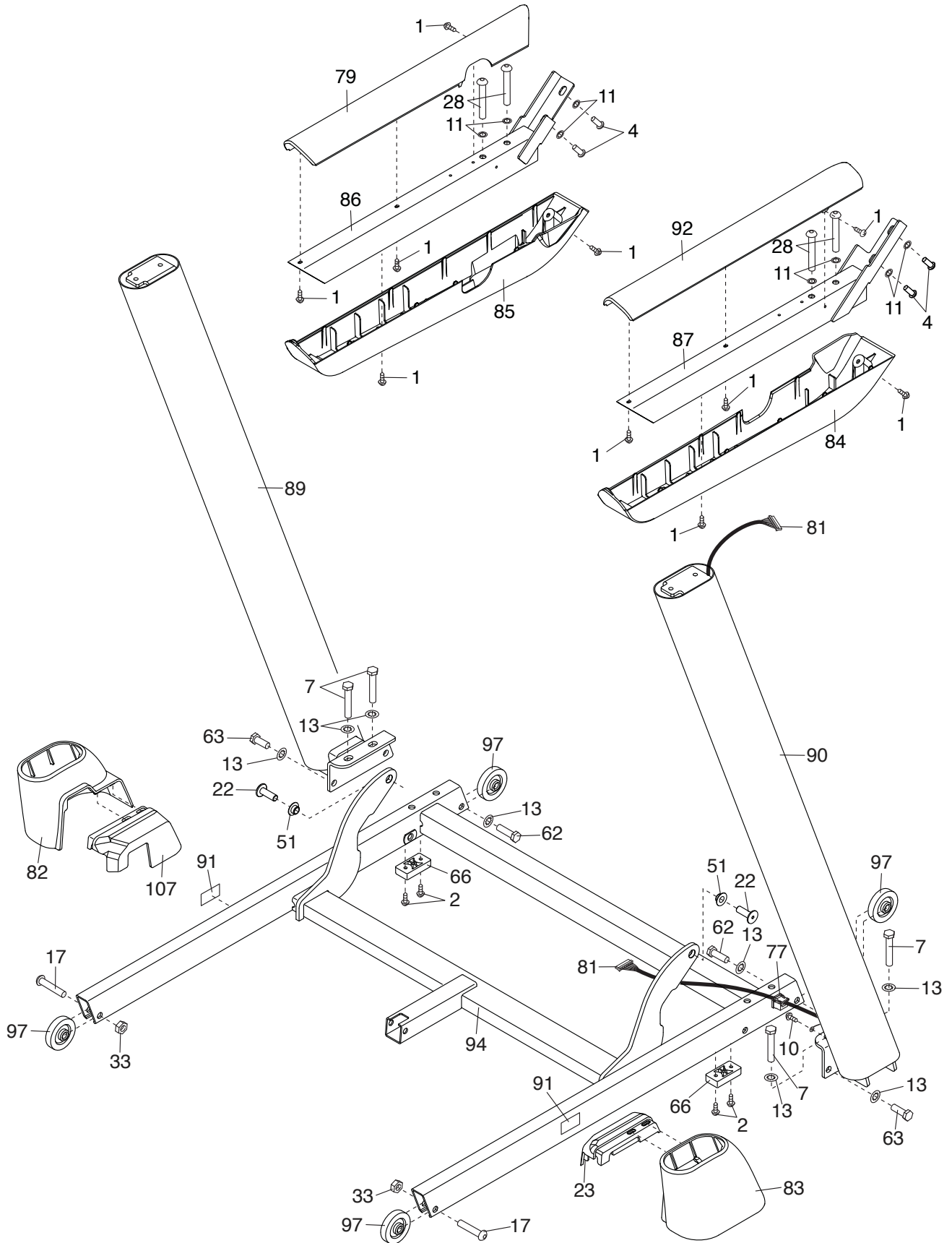

EXPLODED DRAWING D

Model No. PFTL98115.0 R1215A

