

# EXPLODED DRAWING A—Model No. PFTL98908.0

R1208A

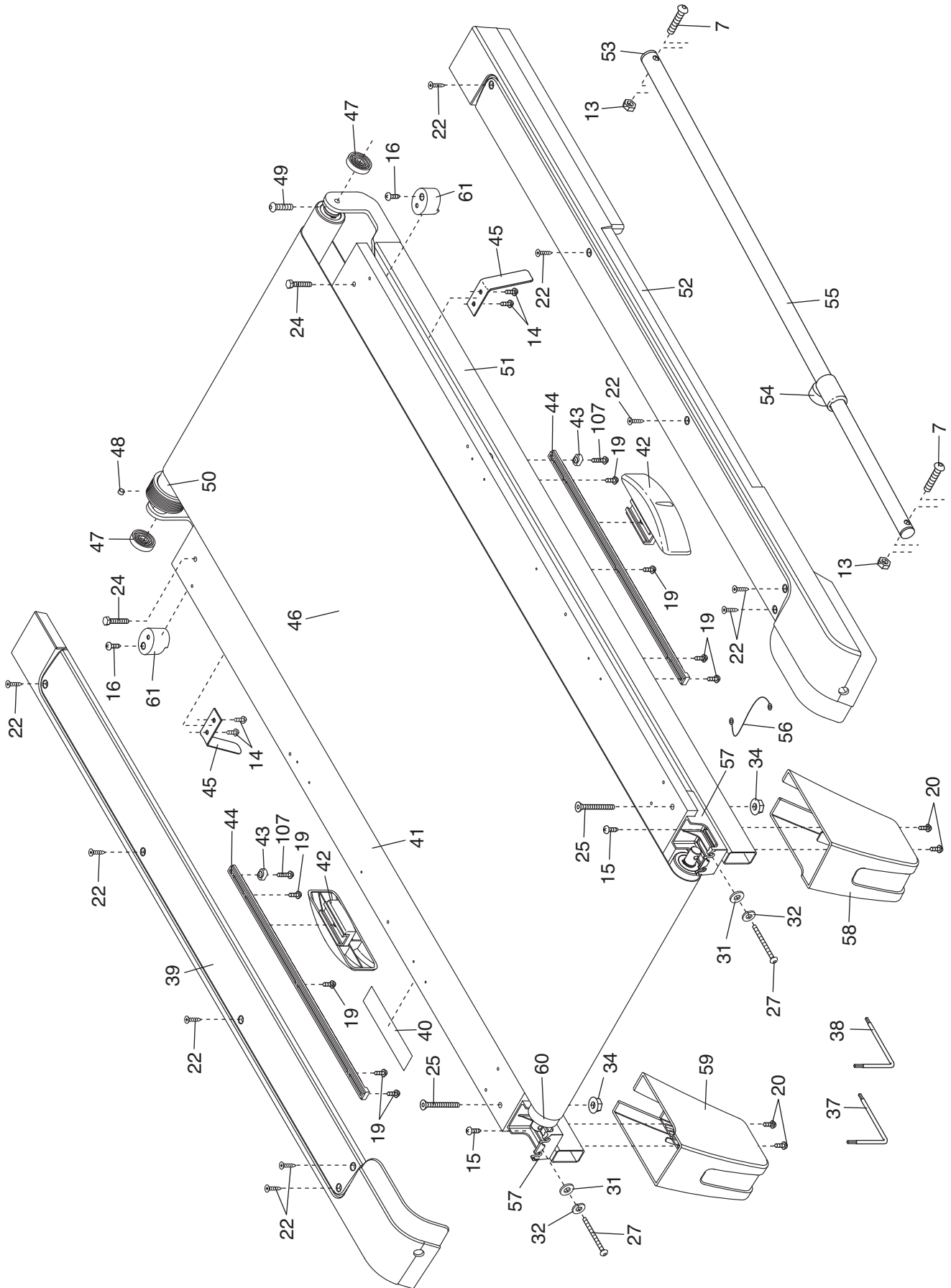

# EXPLODED DRAWING B—Model No. PFTL98908.0

R1208A

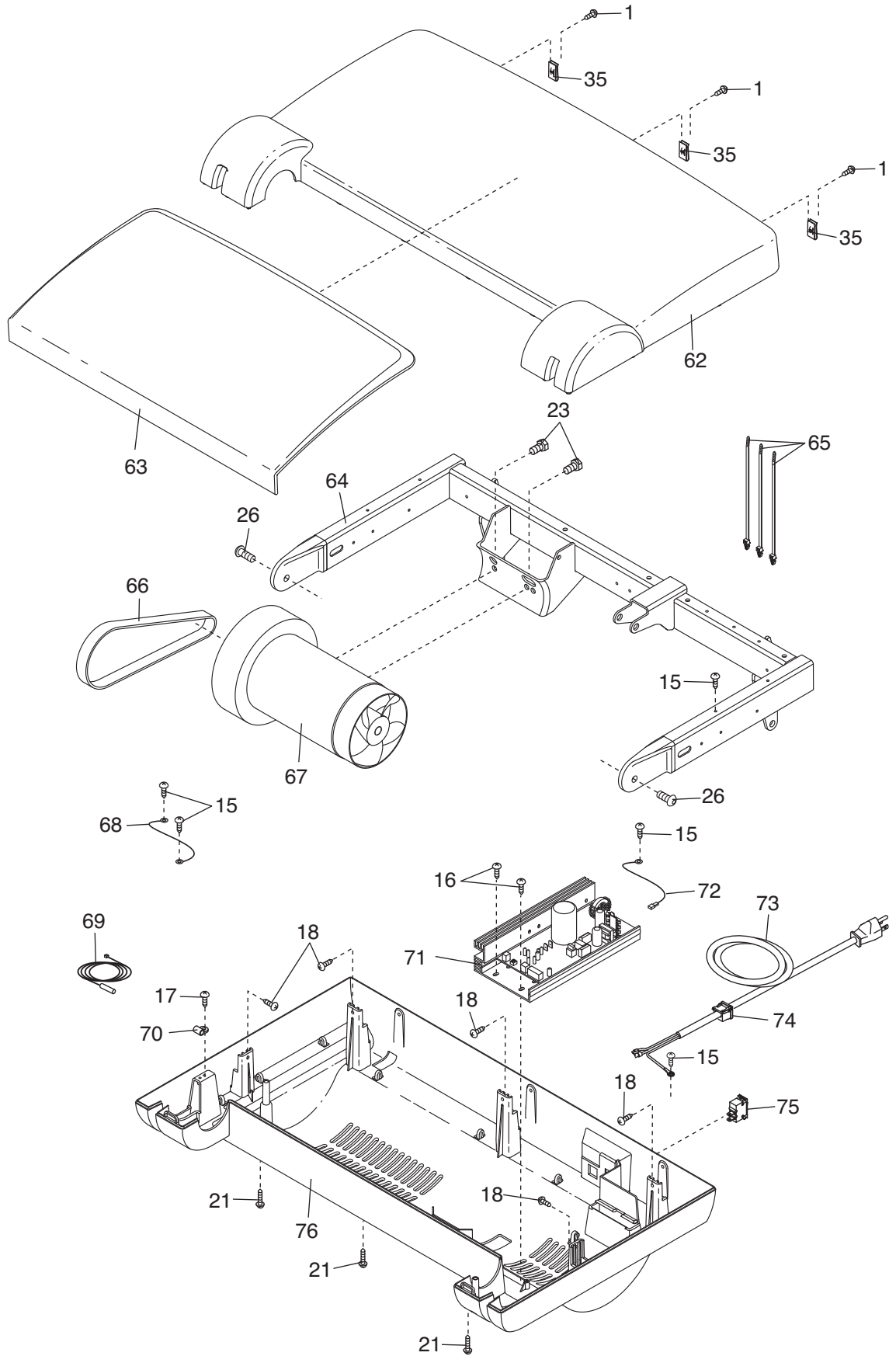

# EXPLODED DRAWING C—Model No. PFTL98908.0

R1208A

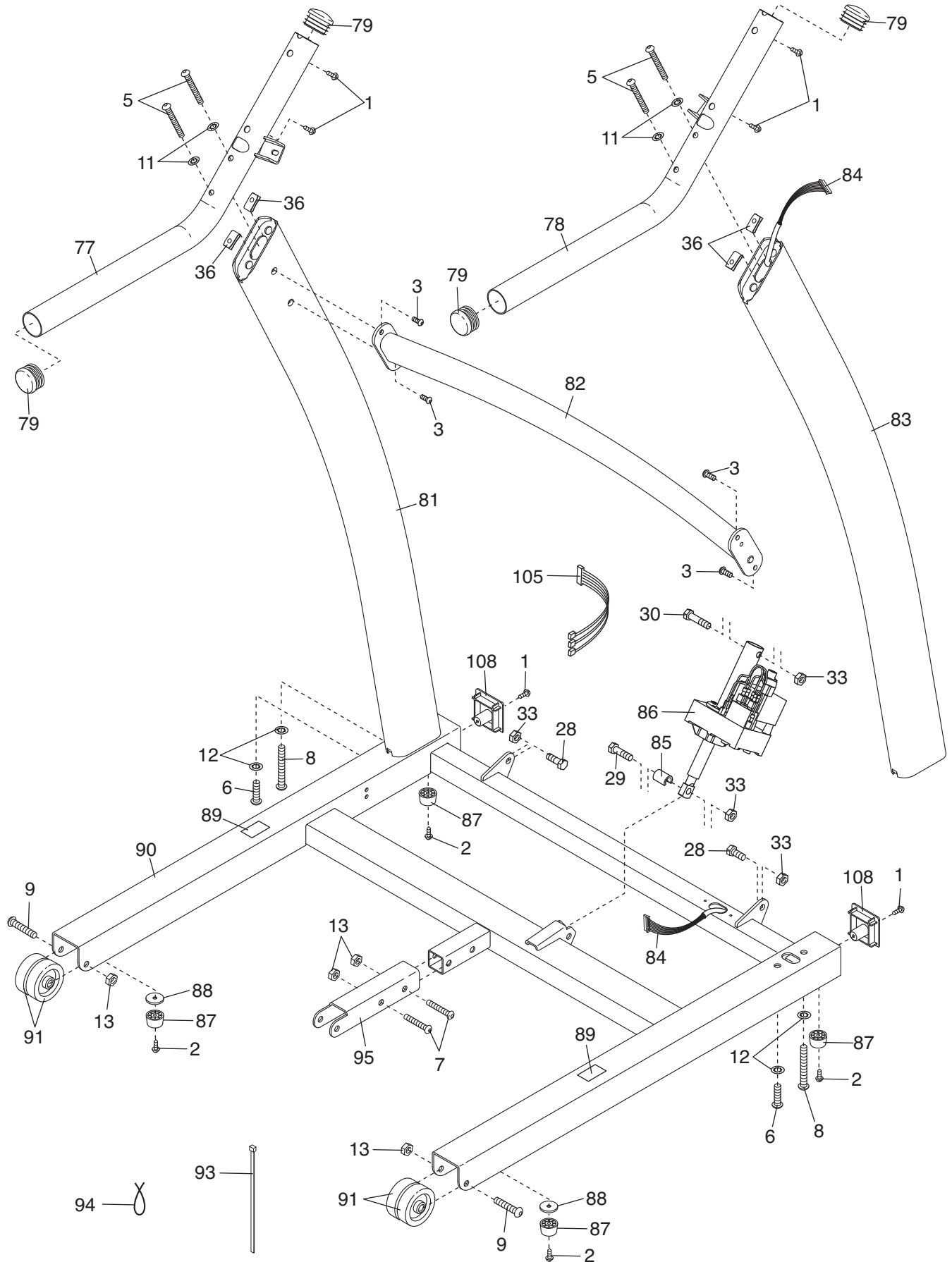

# EXPLODED DRAWING D—Model No. PFTL98908.0

R1208A

