

EXPLODED DRAWING A

Model No. PFTL99013.0 R1113B

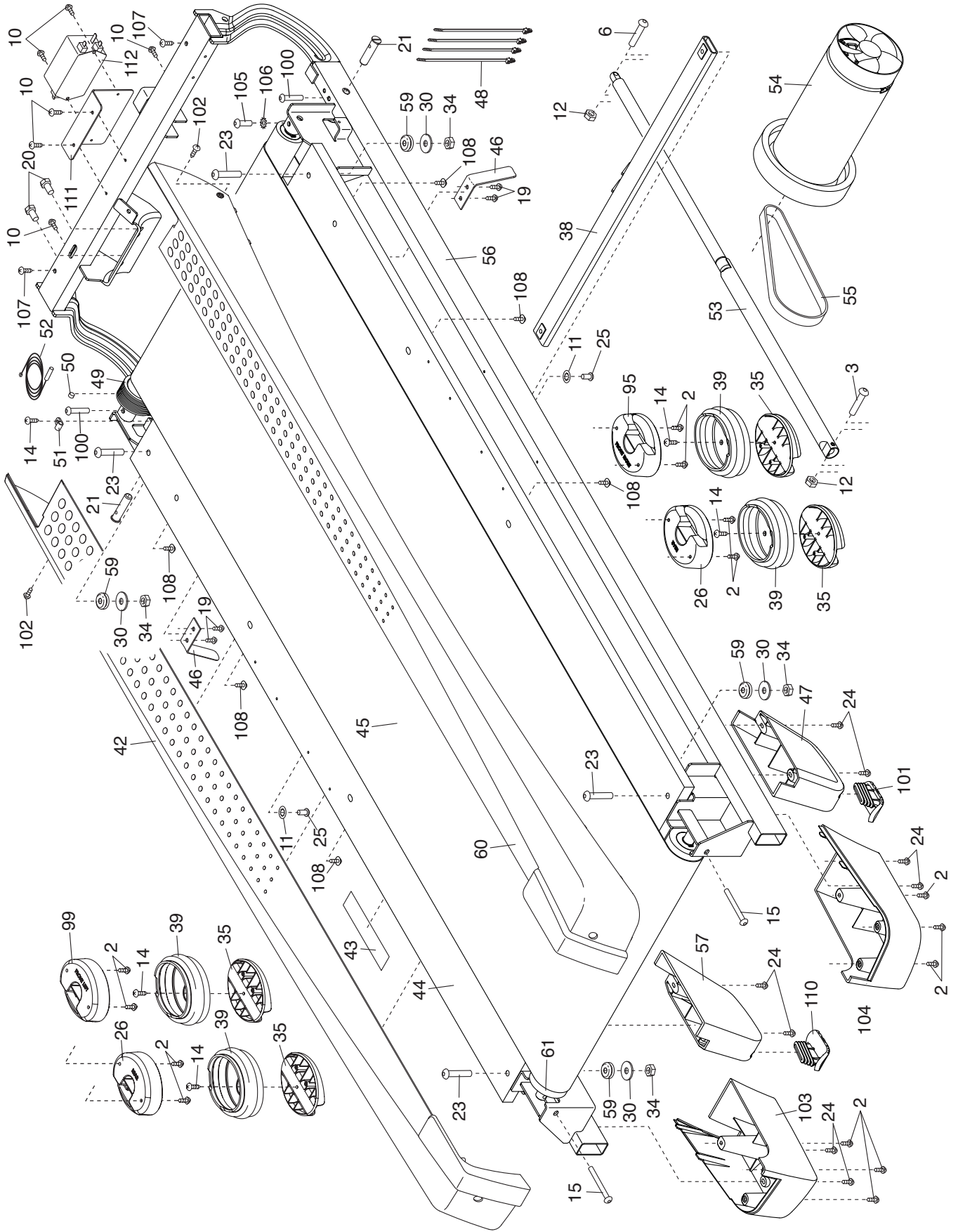

EXPLODED DRAWING B

Model No. PFTL99013.0 R1113B

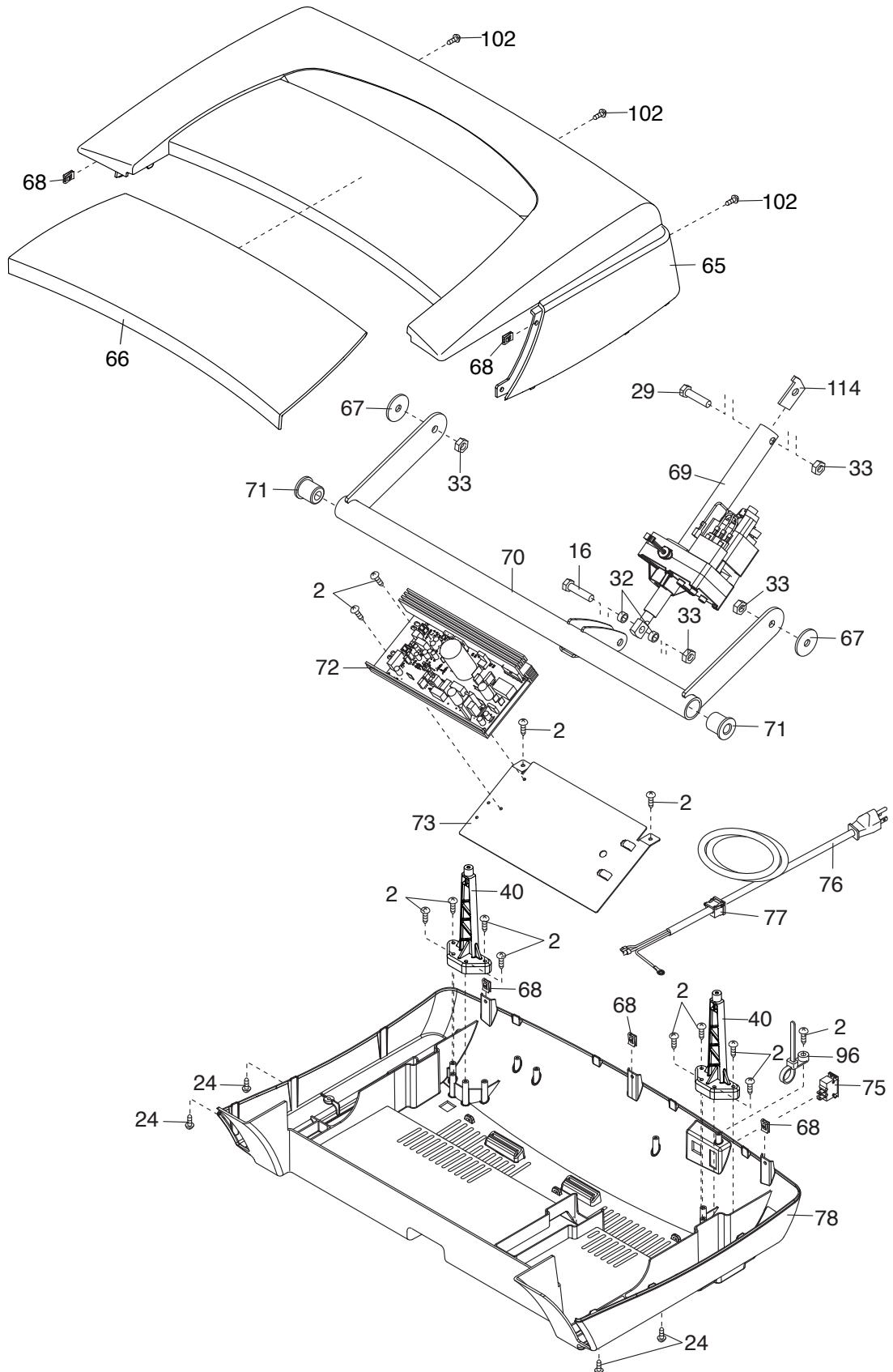

EXPLODED DRAWING C

Model No. PFTL99013.0 R1113B

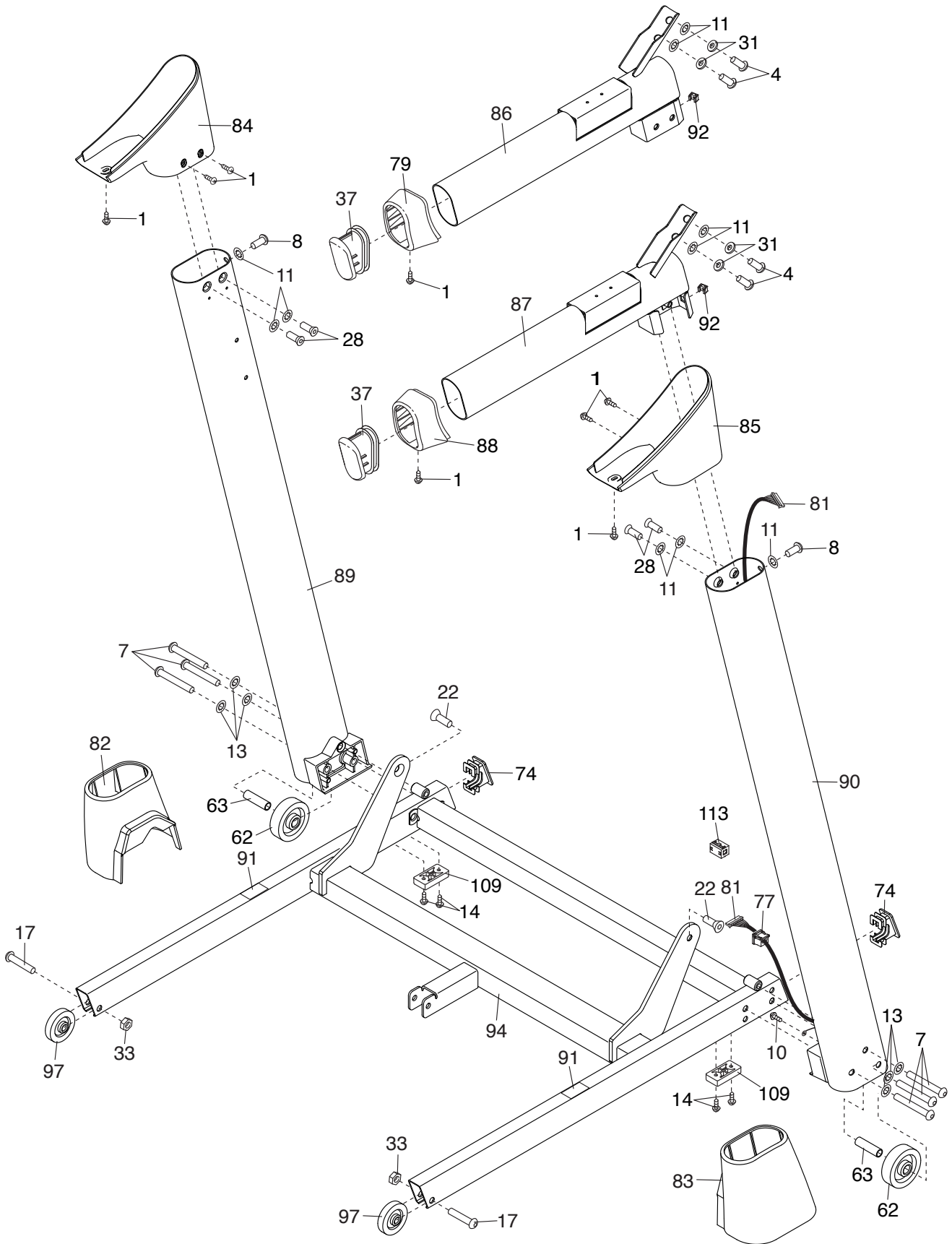

EXPLODED DRAWING D

Model No. PFTL99013.0 R1113B

