

EXPLODED DRAWING B

Model No. PFTL99013.2 R1114A

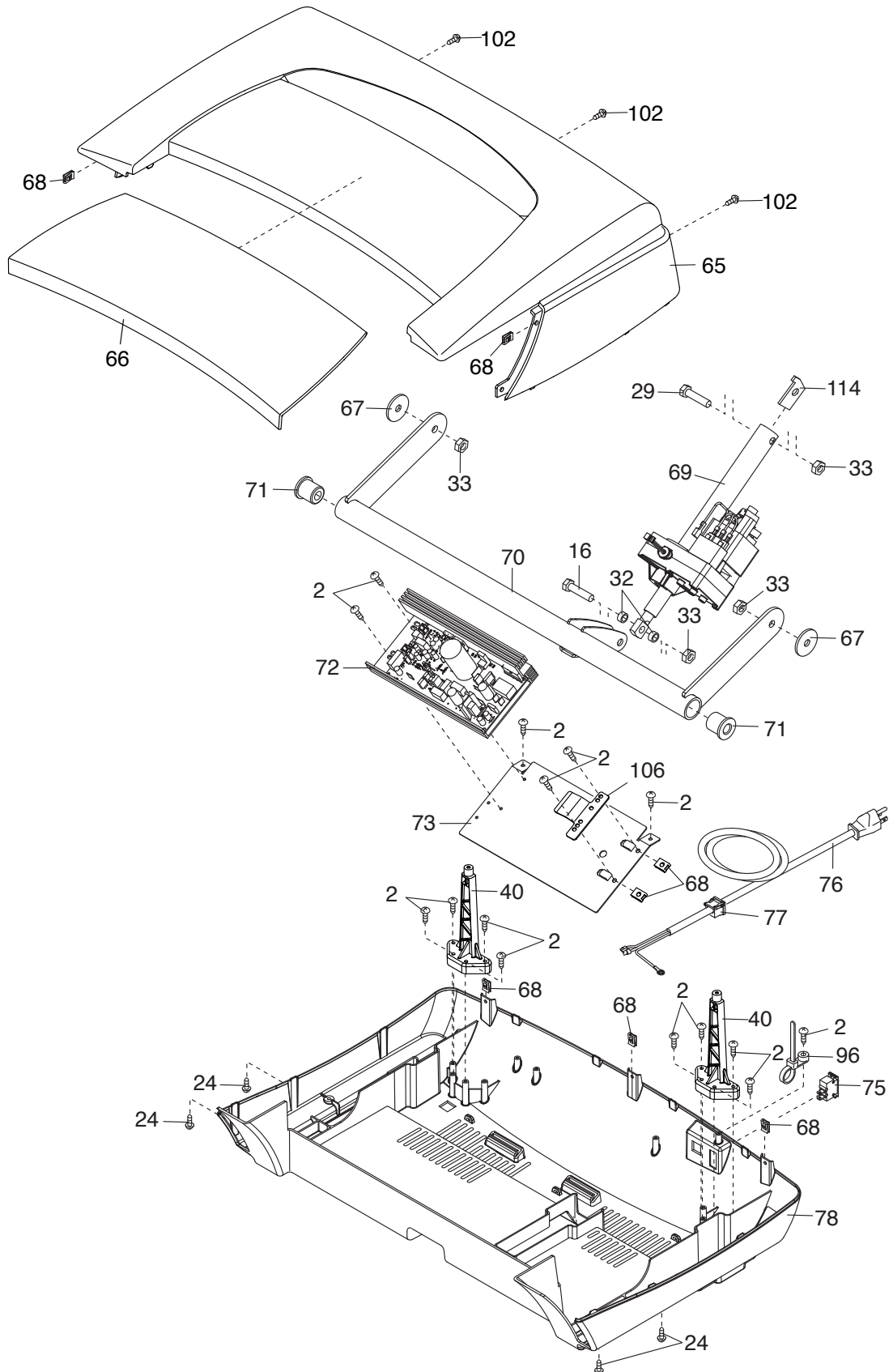

EXPLODED DRAWING C

Model No. PFTL99013.2 R1114A

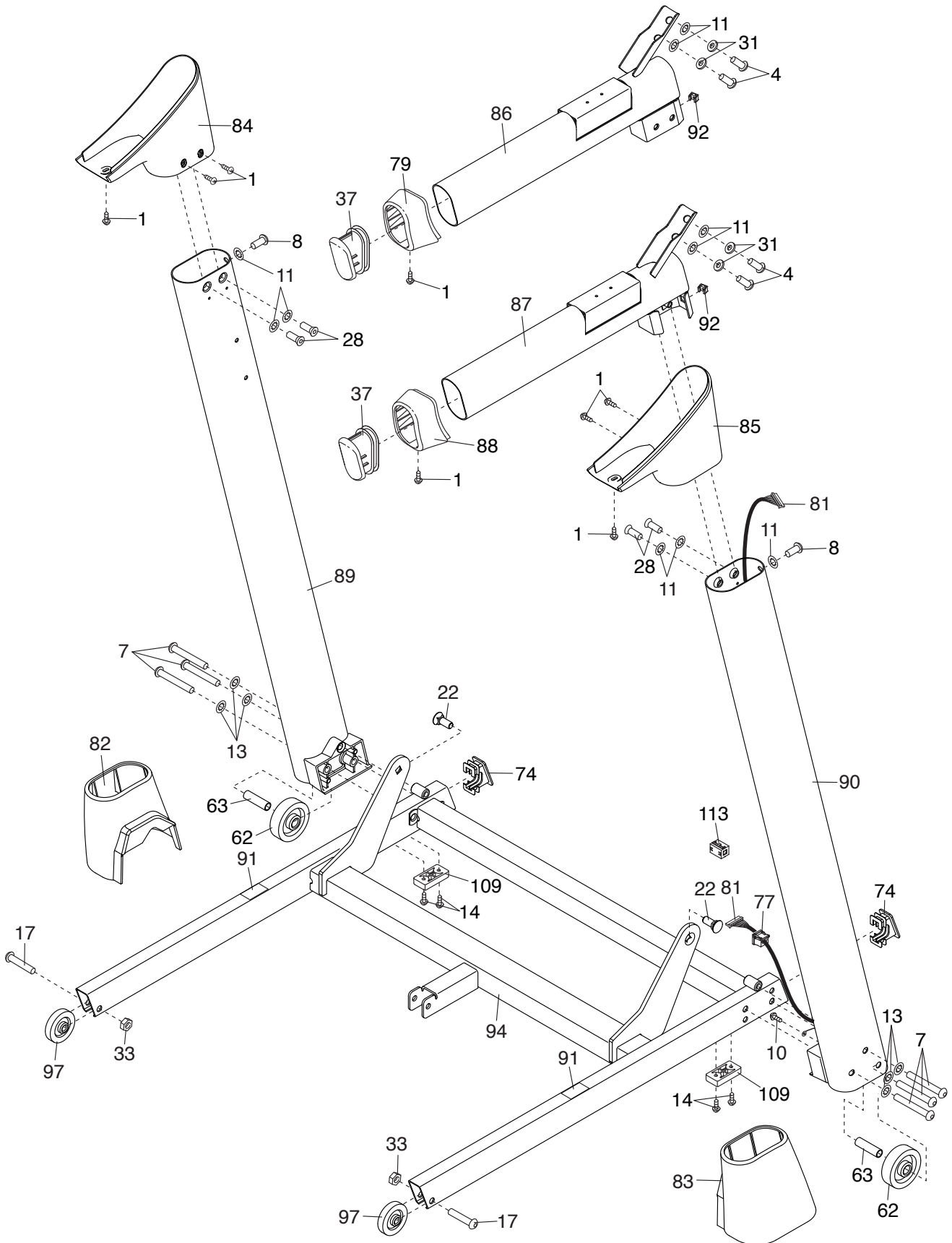

EXPLODED DRAWING D

Model No. PFTL99013.2 R1114A

