

EXPLODED DRAWING A

Model No. PFTL99015.0 R1115B

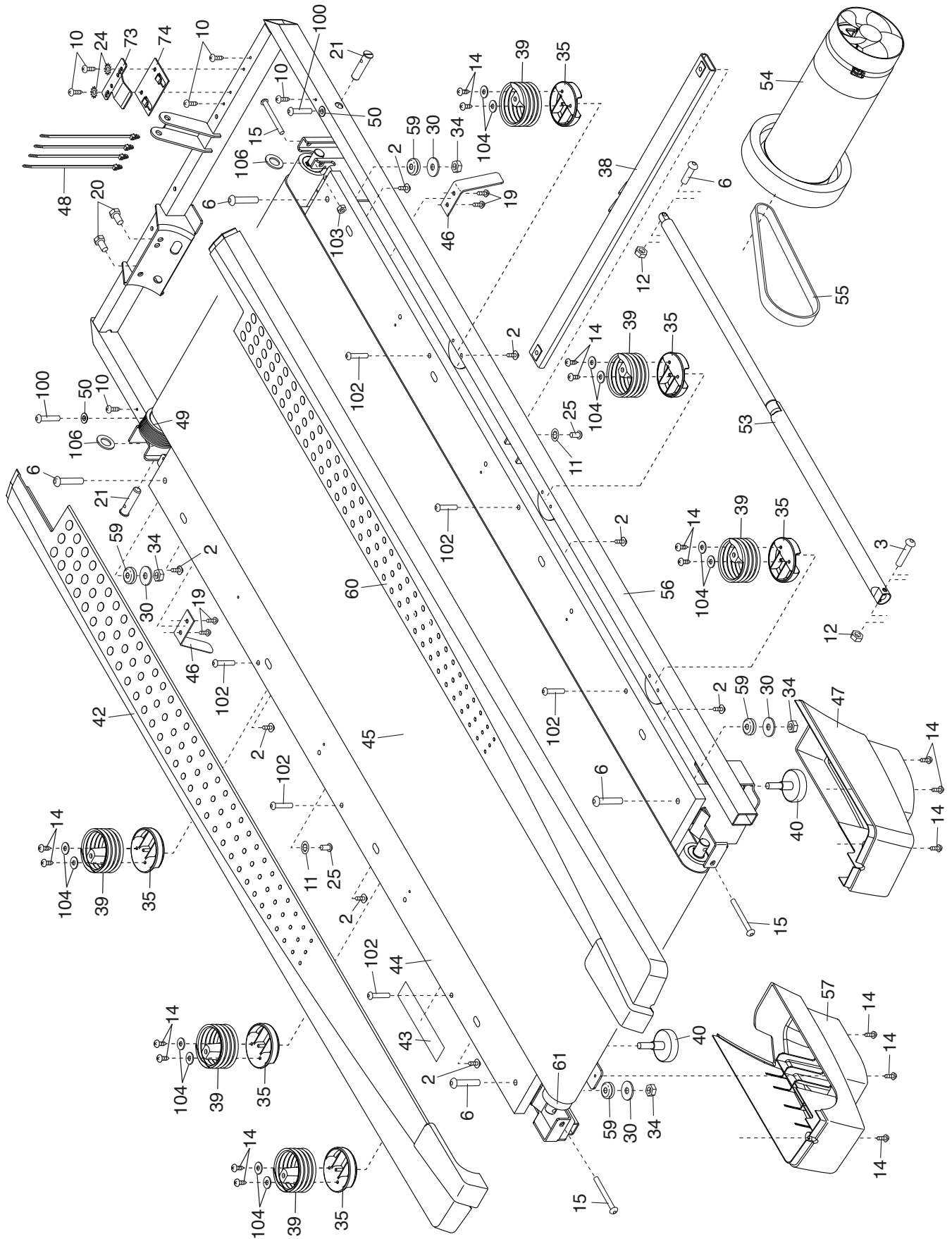

EXPLODED DRAWING B

Model No. PFTL99015.0 R1115B

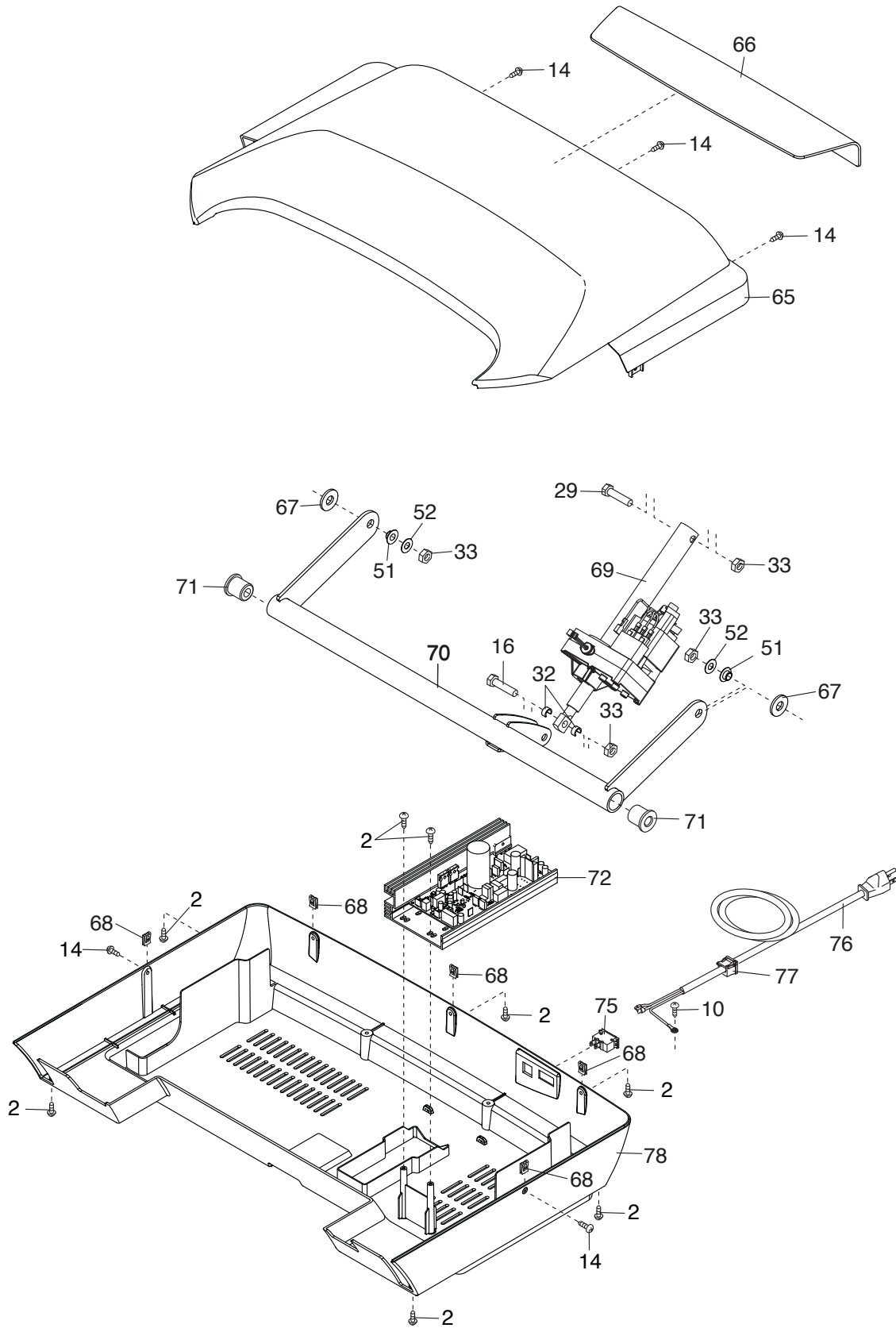

EXPLODED DRAWING C

Model No. PFTL99015.0 R1115B

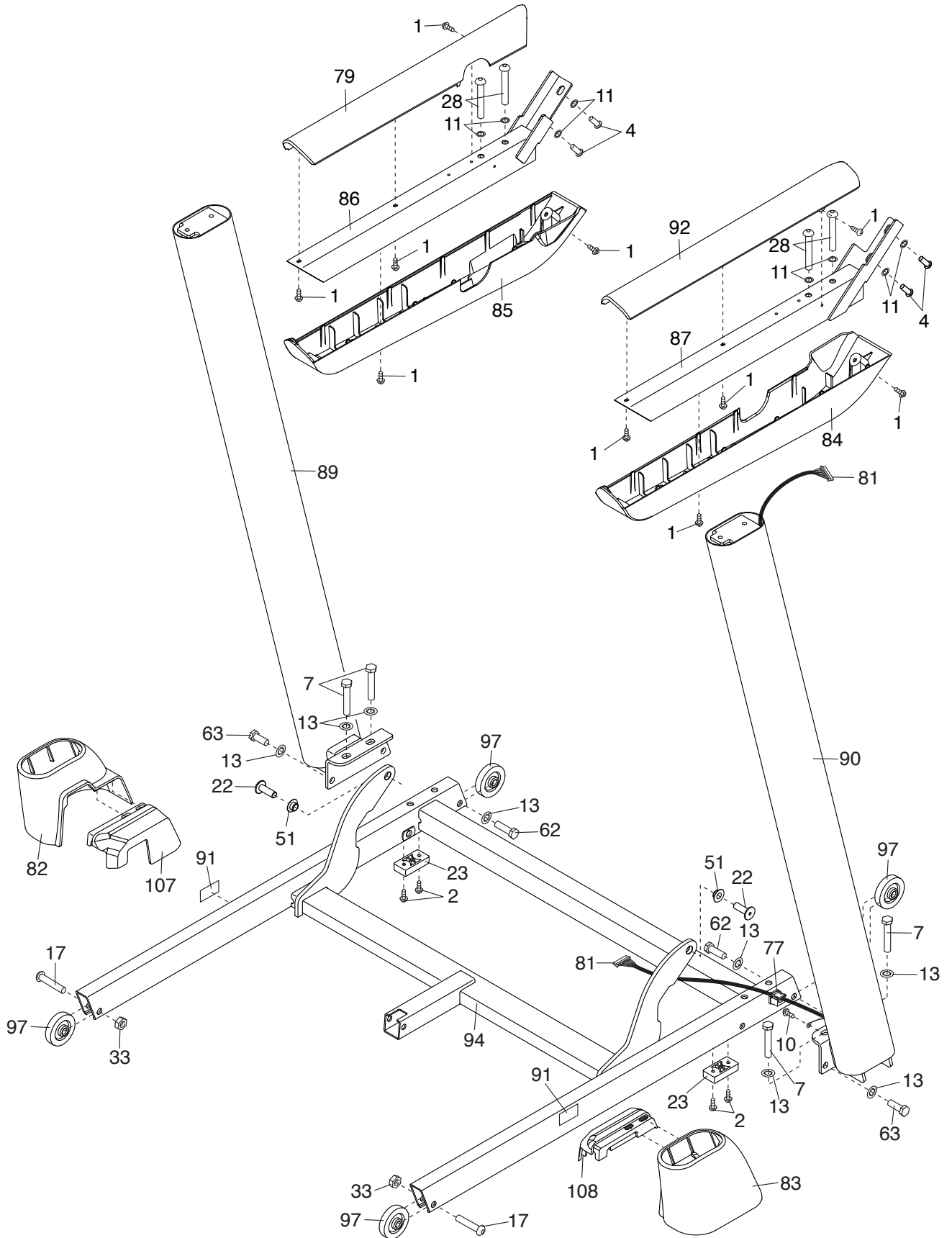

EXPLODED DRAWING D

Model No. PFTL99015.0 R1115B

