

EXPLODED DRAWING A—Model No. PFTL99106.0

R1106A

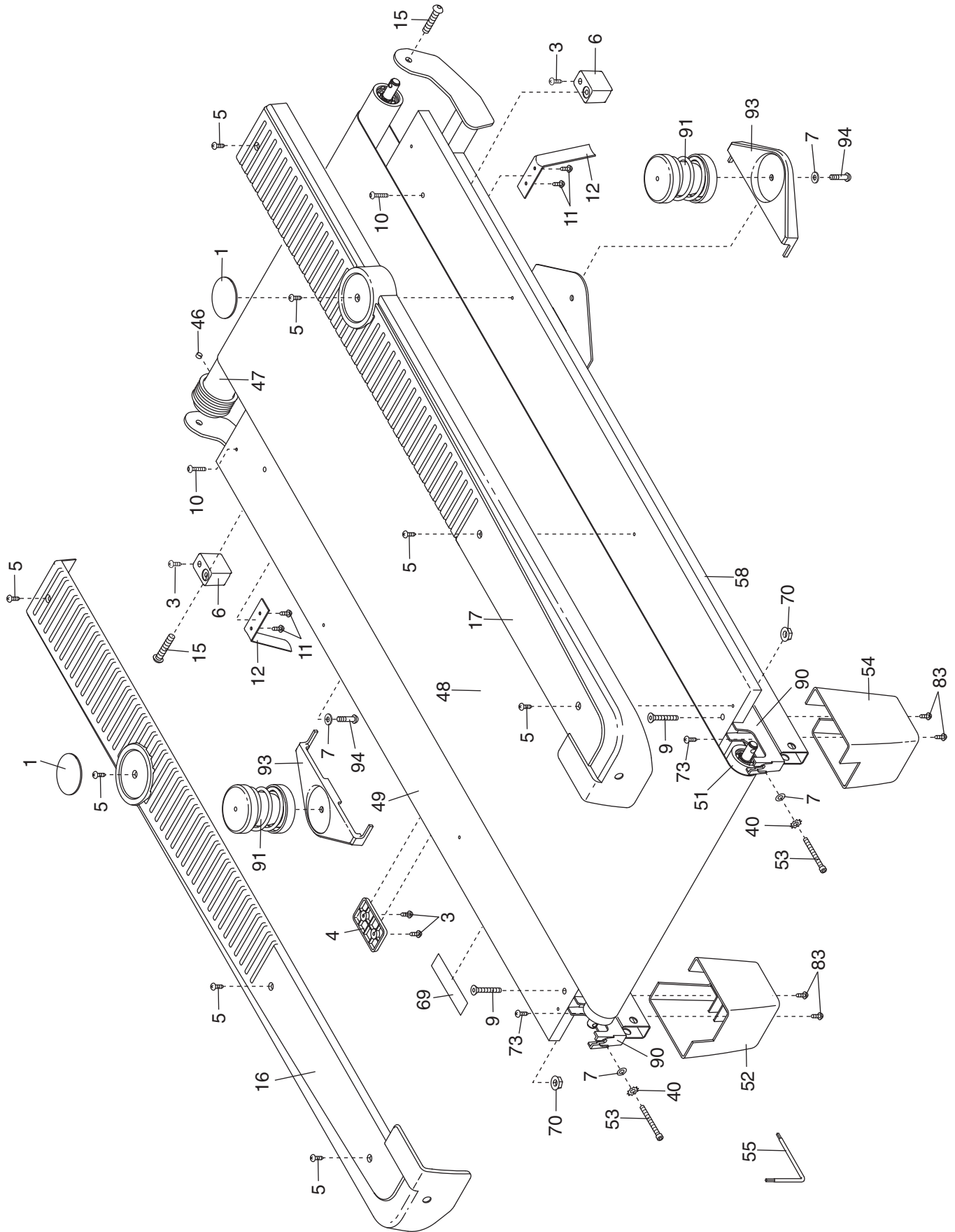

EXPLODED DRAWING C—Model No. PFTL99106.0

R1106A

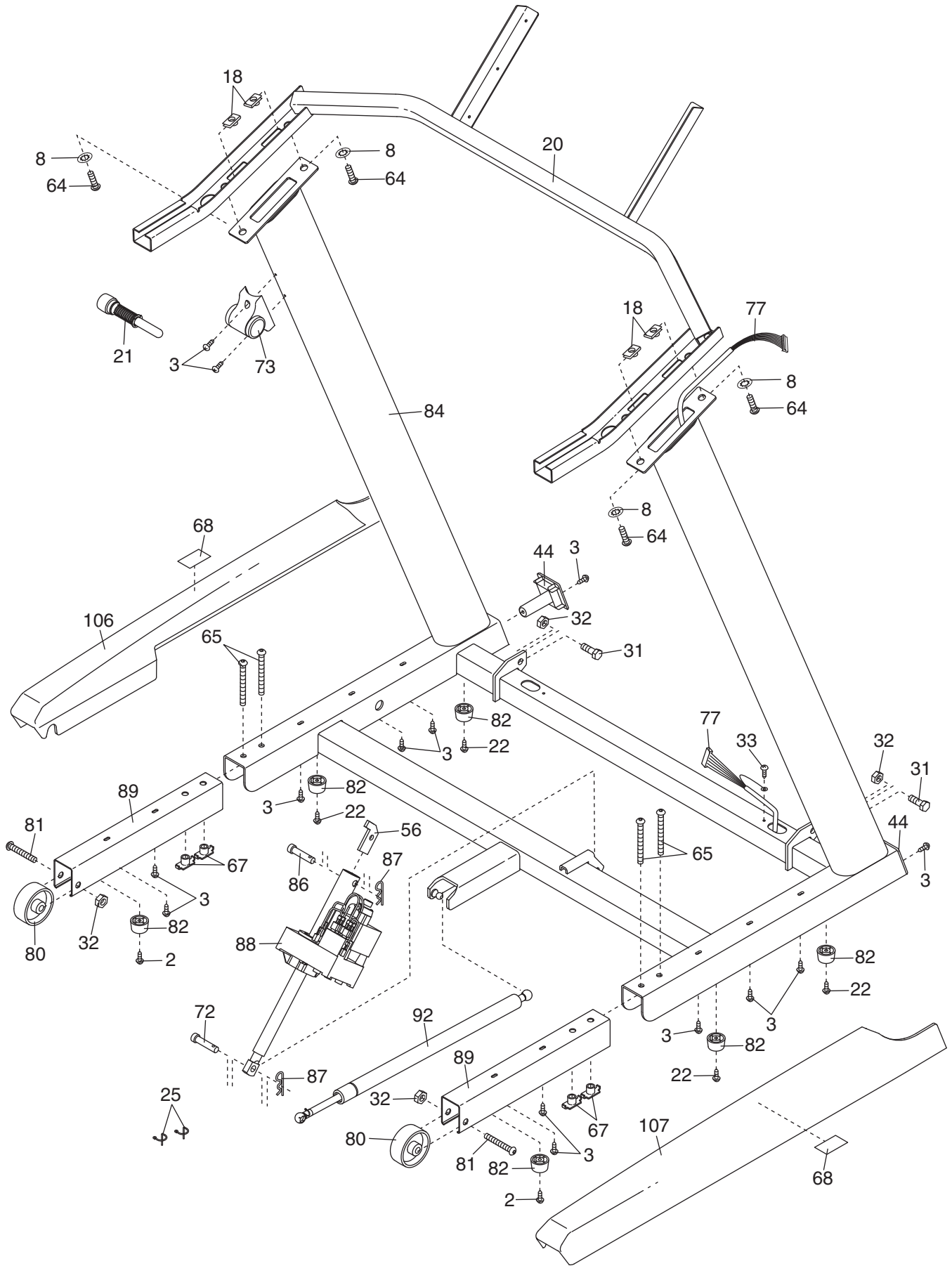

EXPLODED DRAWING D—Model No. PFTL99106.0

R1106A

