

# EXPLODED DRAWING A—Model No. PFTL99507.0

R1007A

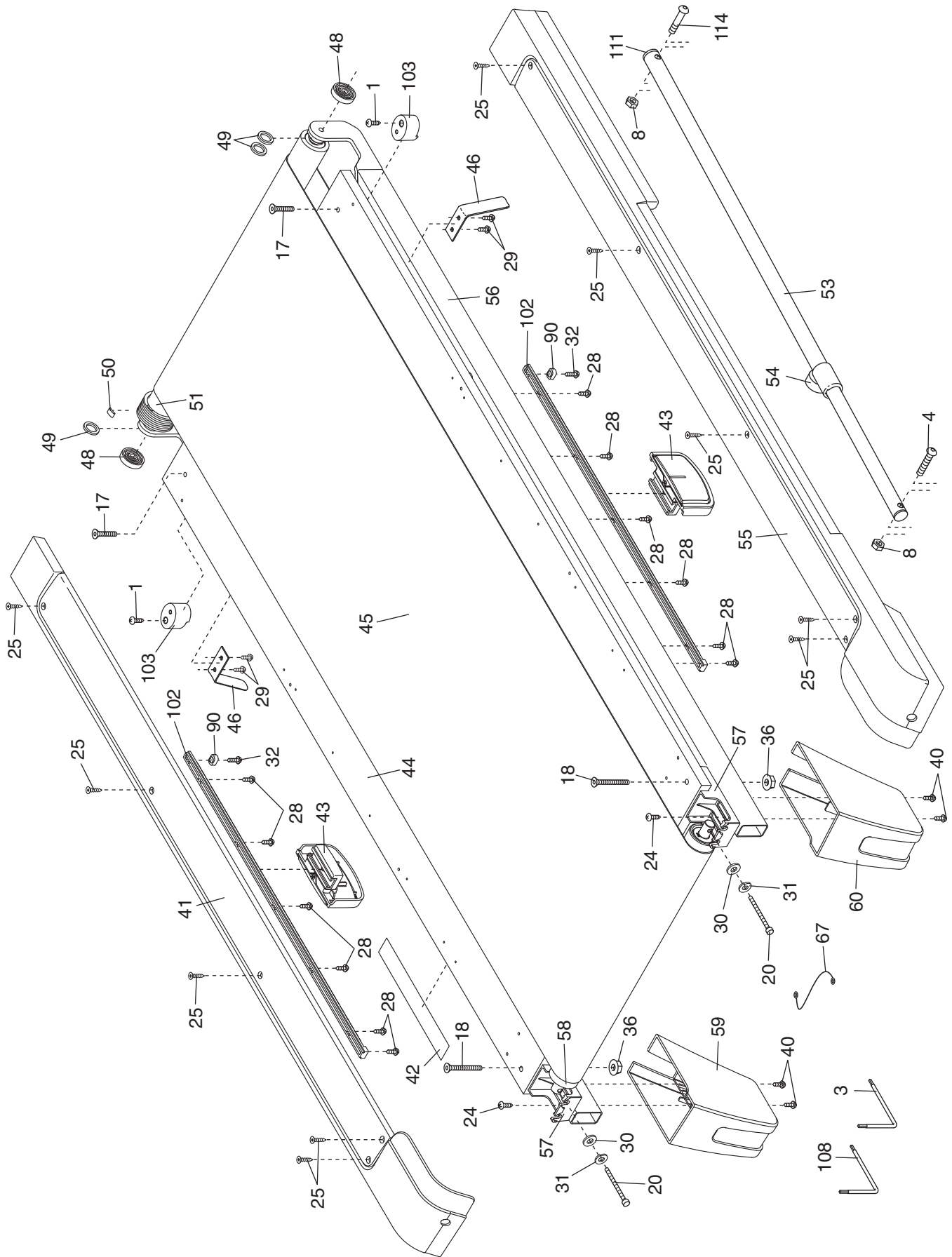

# EXPLODED DRAWING B—Model No. PFTL99507.0

R1007A

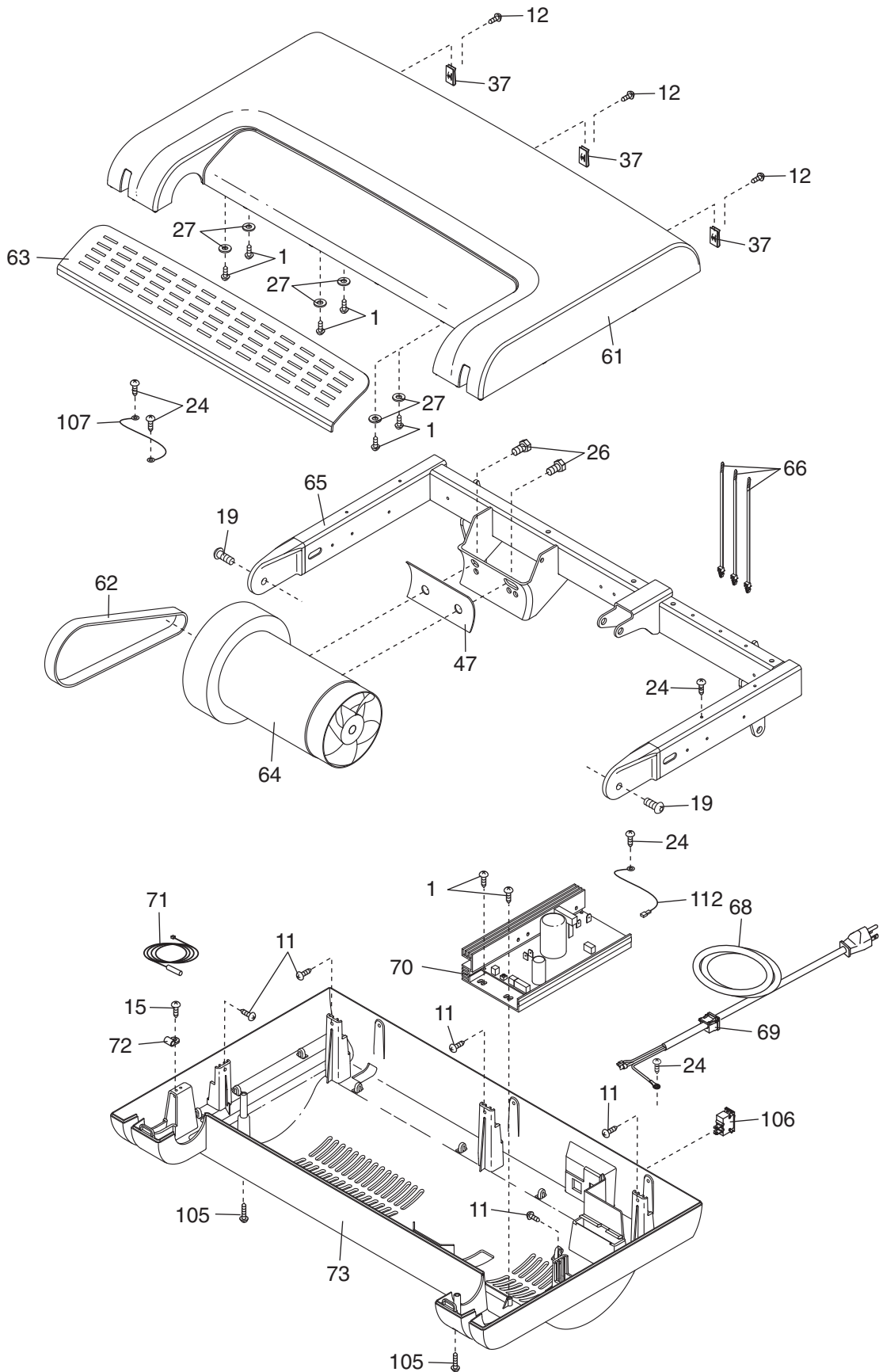

# EXPLODED DRAWING C—Model No. PFTL99507.0

R1007A

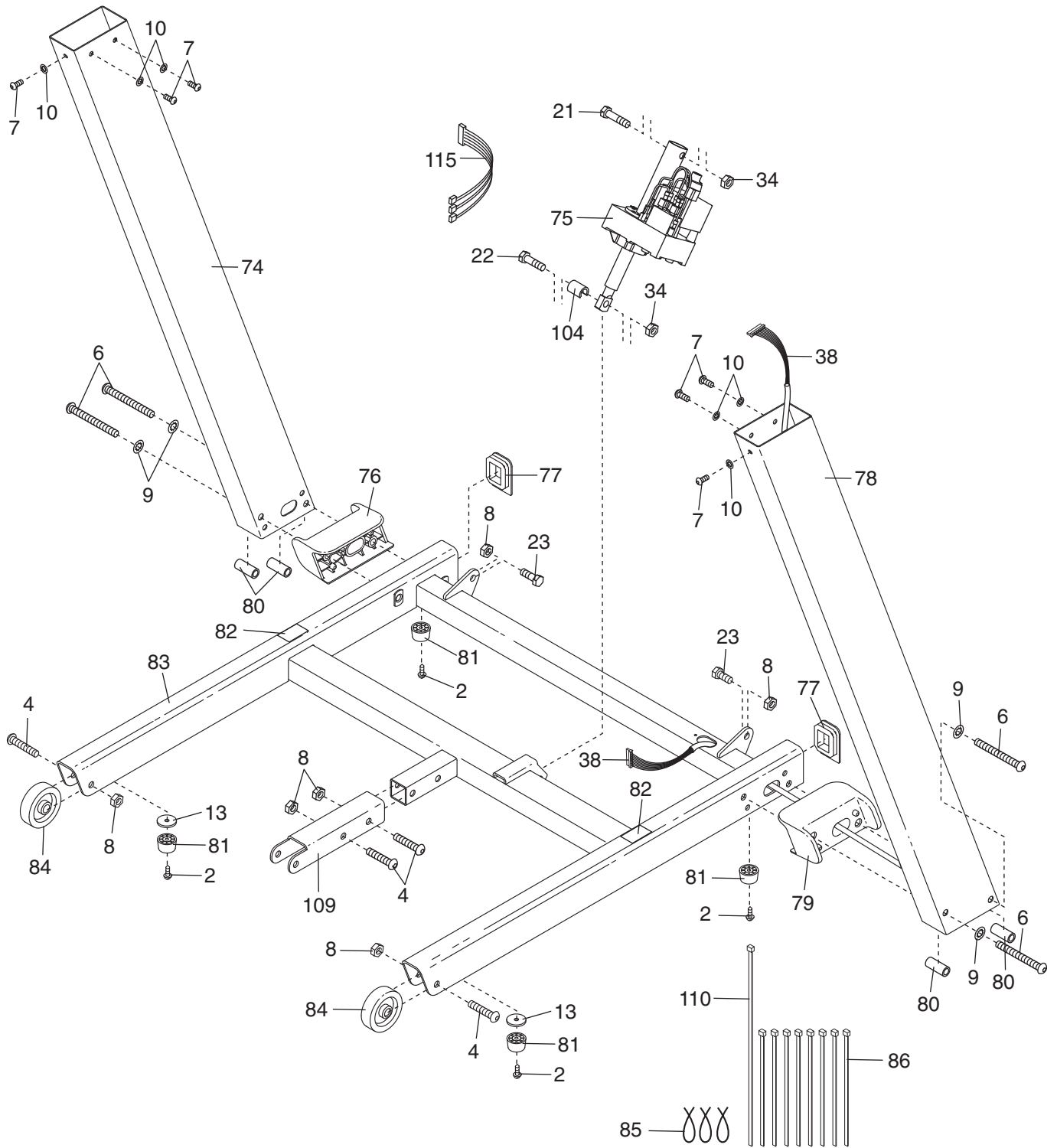

# EXPLODED DRAWING D—Model No. PFTL99507.0

R1007A

