

EXPLODED DRAWING A—Model No. PFTL99507.1

R1207A

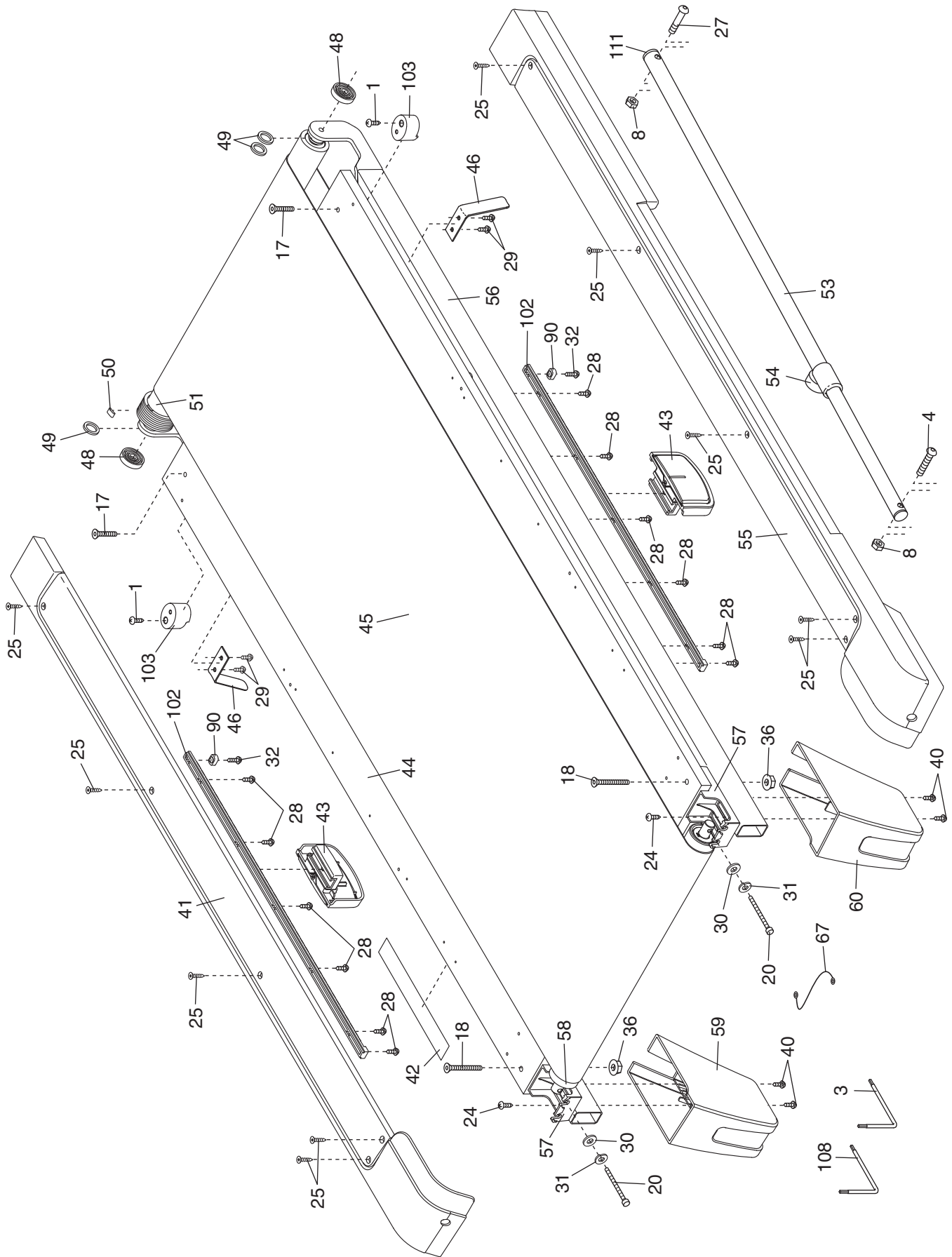

EXPLODED DRAWING B—Model No. PFTL99507.1

R1207A

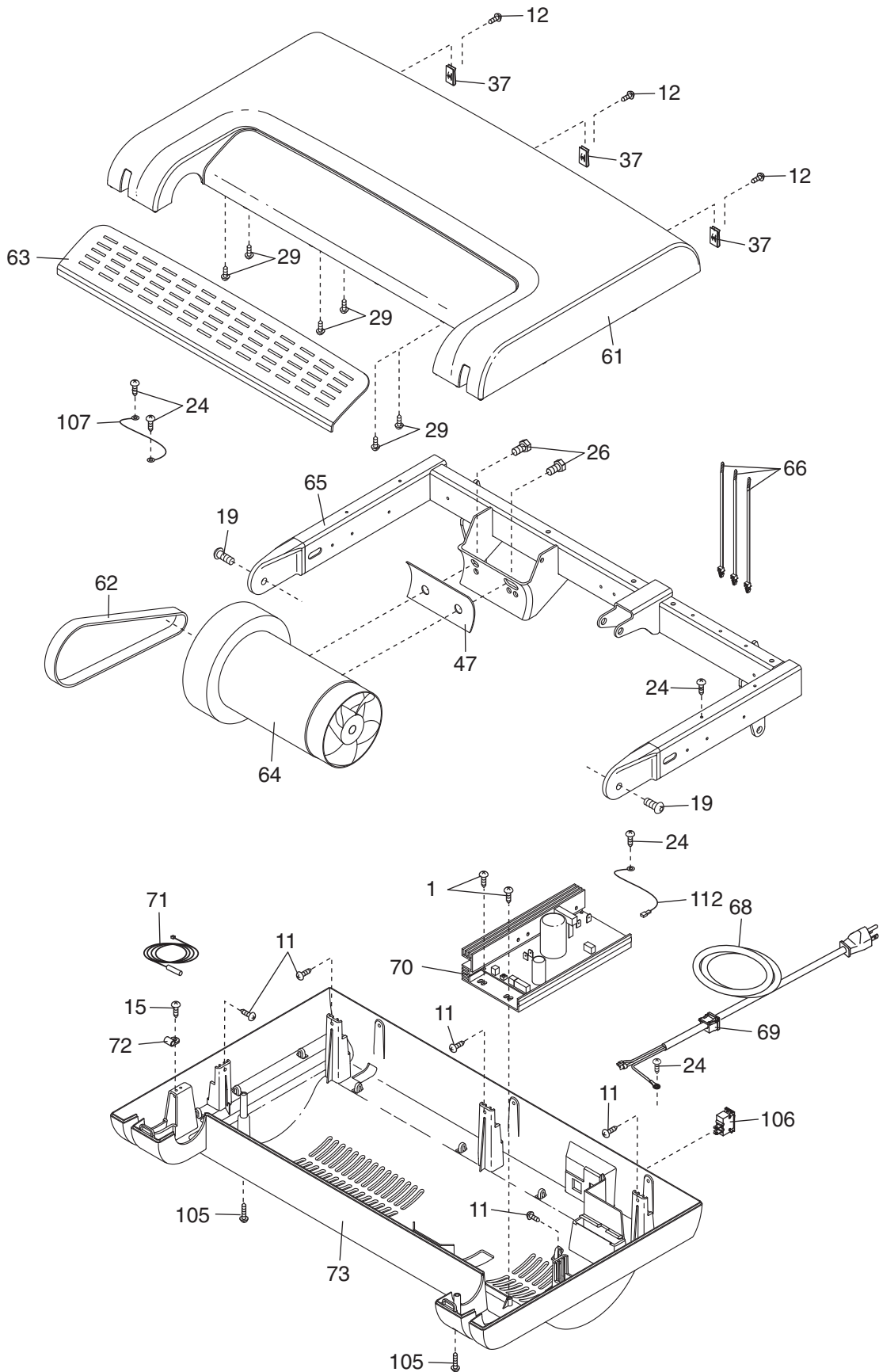

EXPLODED DRAWING D—Model No. PFTL99507.1

R1207A

