

EXPLODED DRAWING A

Model No. PFTL99513.2 R1114A

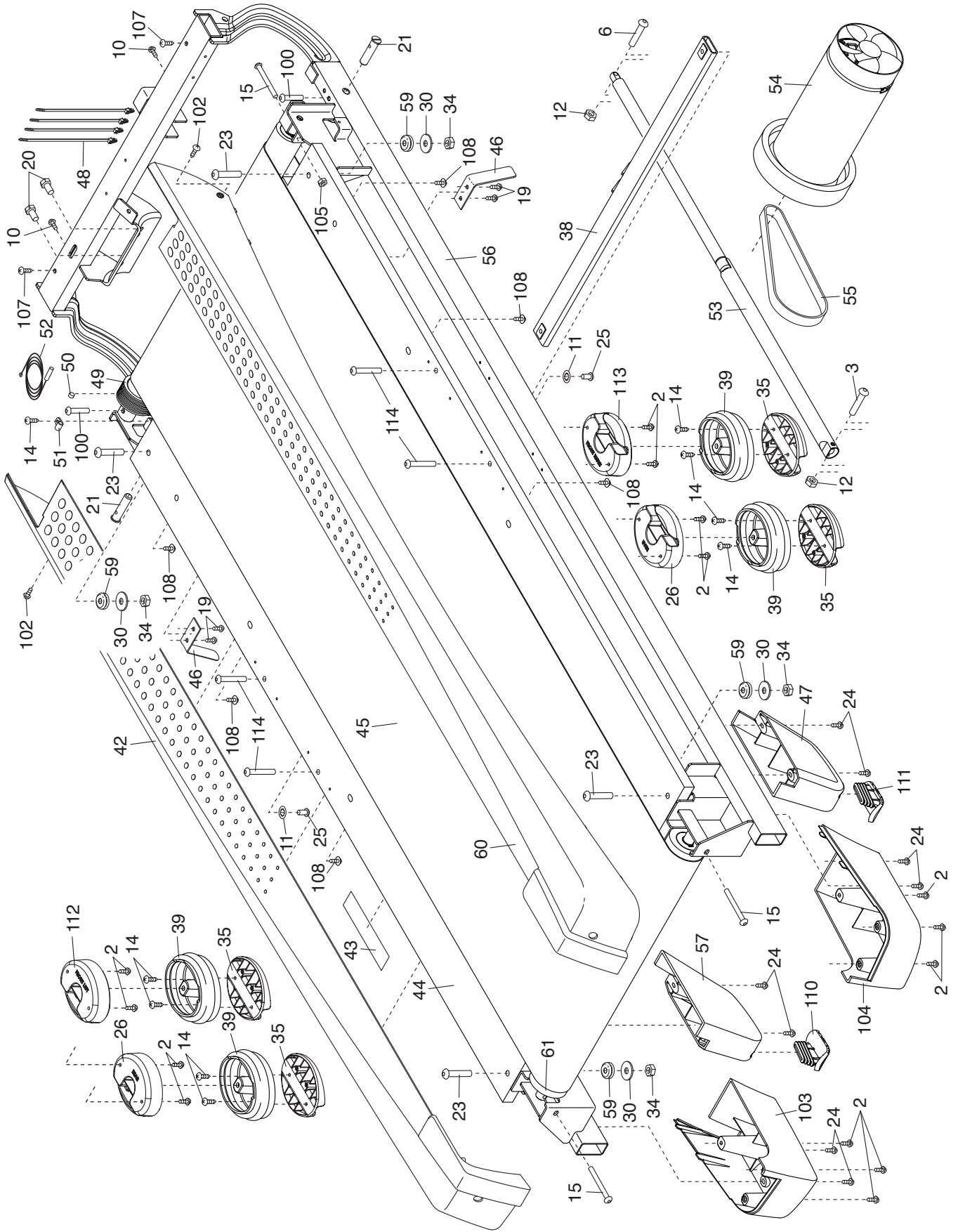

EXPLODED DRAWING B

Model No. PFTL99513.2 R1114A

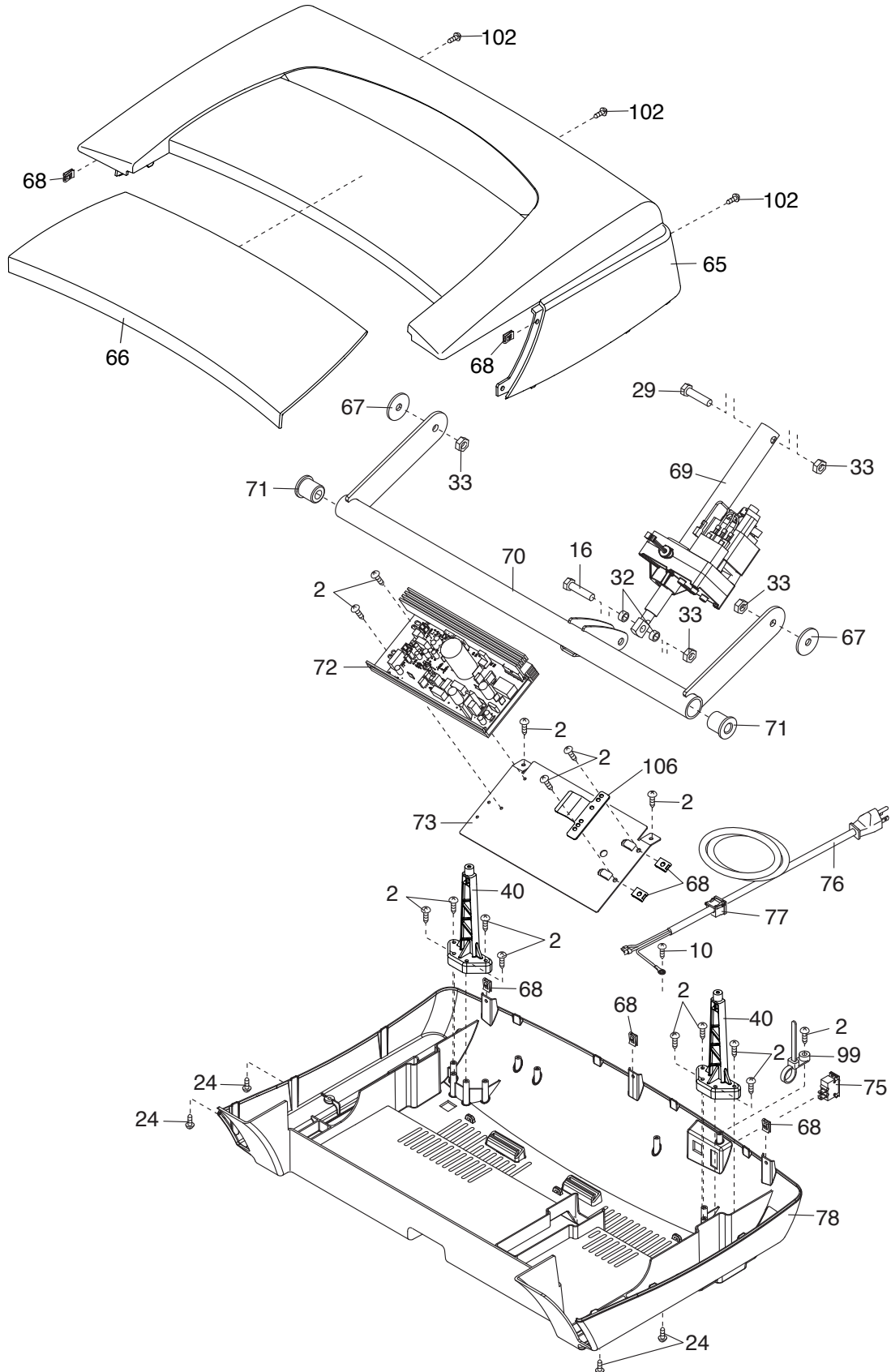

EXPLODED DRAWING C

Model No. PFTL99513.2 R1114A

