

EXPLODED DRAWING A

Model No. PFTL99518.0 R1118B

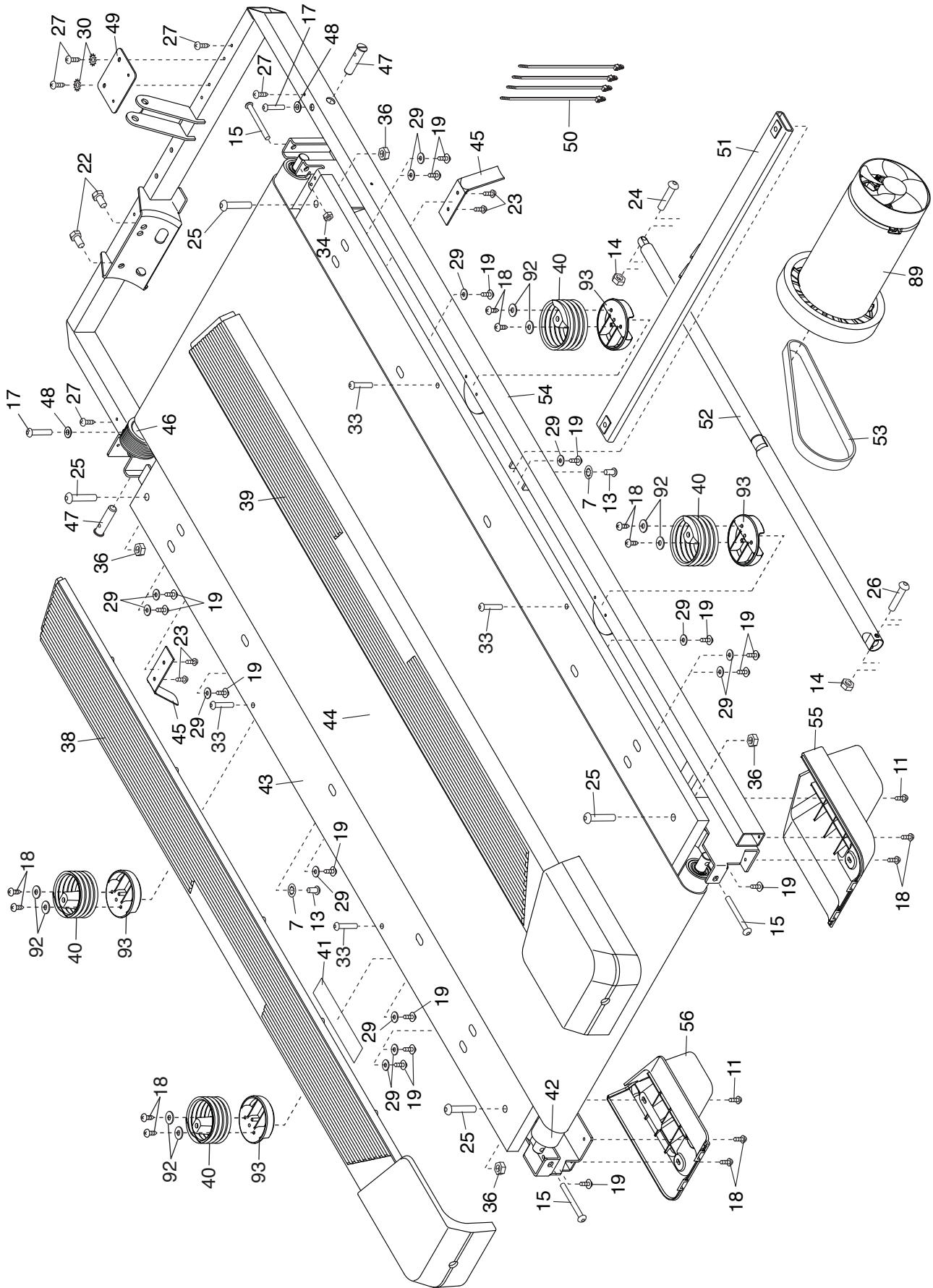

EXPLODED DRAWING B

Model No. PFTL99518.0 R1118B

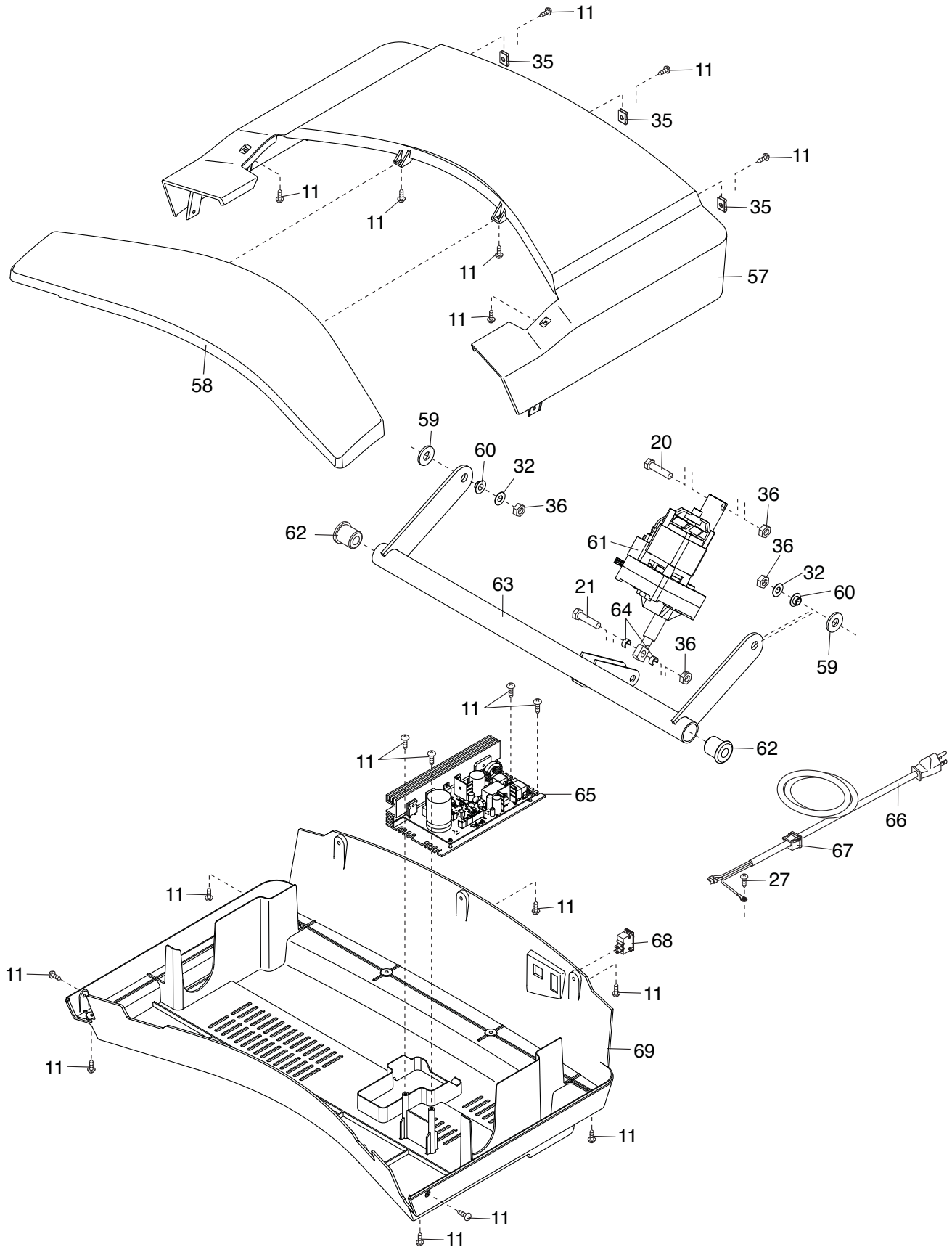

EXPLODED DRAWING C

Model No. PFTL99518.0 R1118B

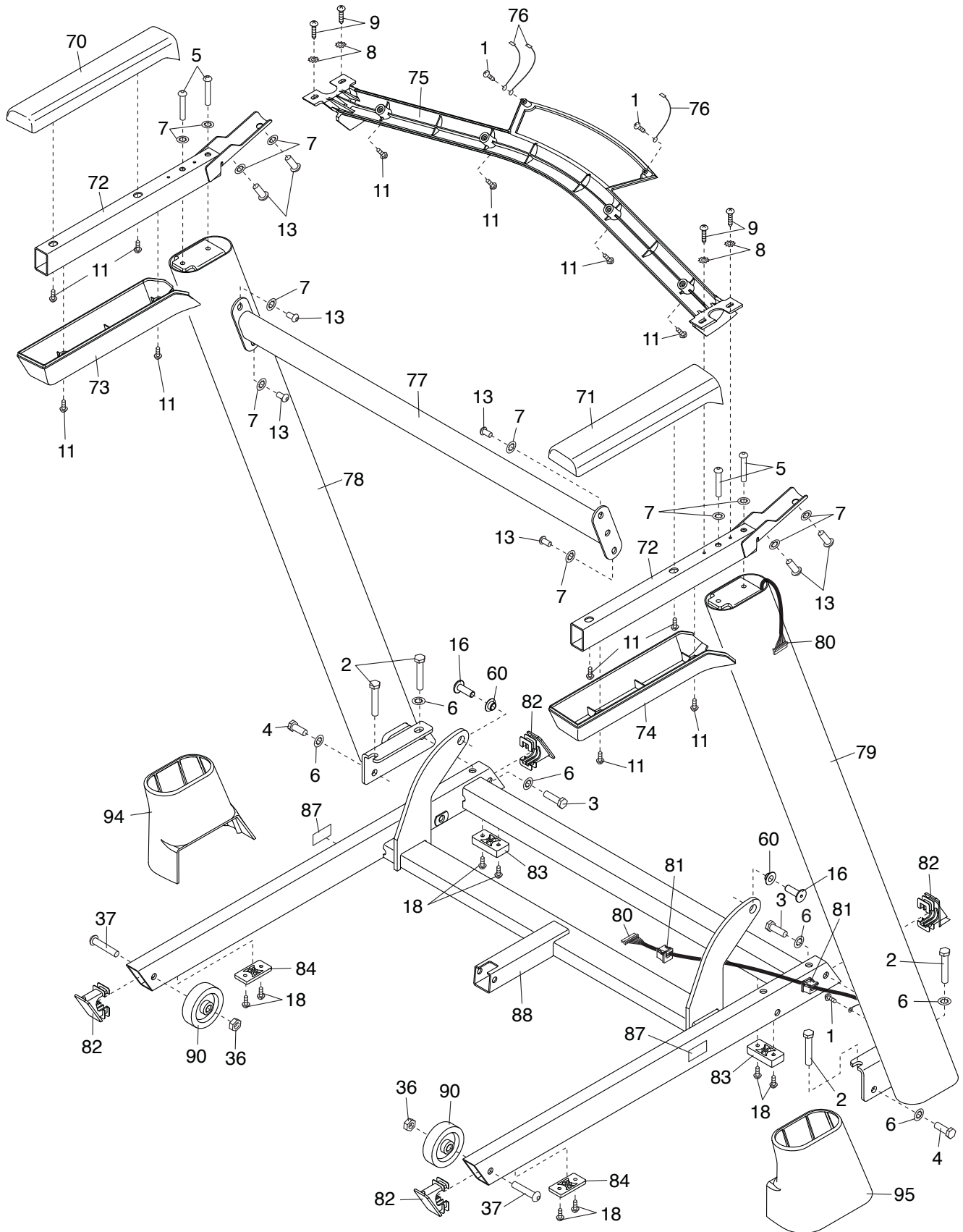

EXPLODED DRAWING D

Model No. PFTL99518.0 R1118B

