

EXPLODED DRAWING—Model No. PFTL99600

R0202A

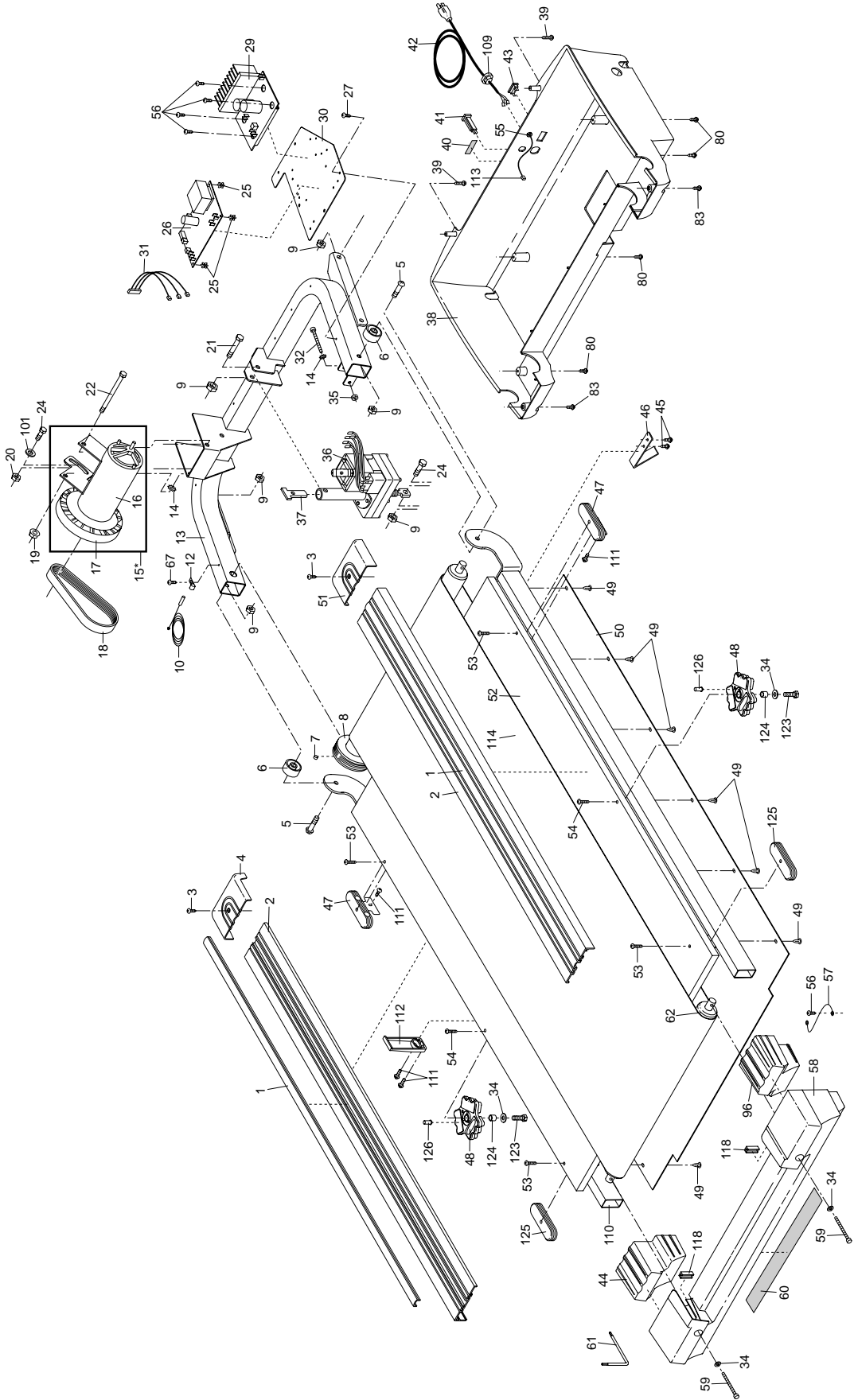

To identify the parts shown on this exploded drawing, refer to the PART LIST on page 23 of the USER'S MANUAL.

EXPLODED DRAWING—Model No. PFTL99600

R0202A

