

# EXPLODED DRAWING—Model No. PFTL99601

R0402A

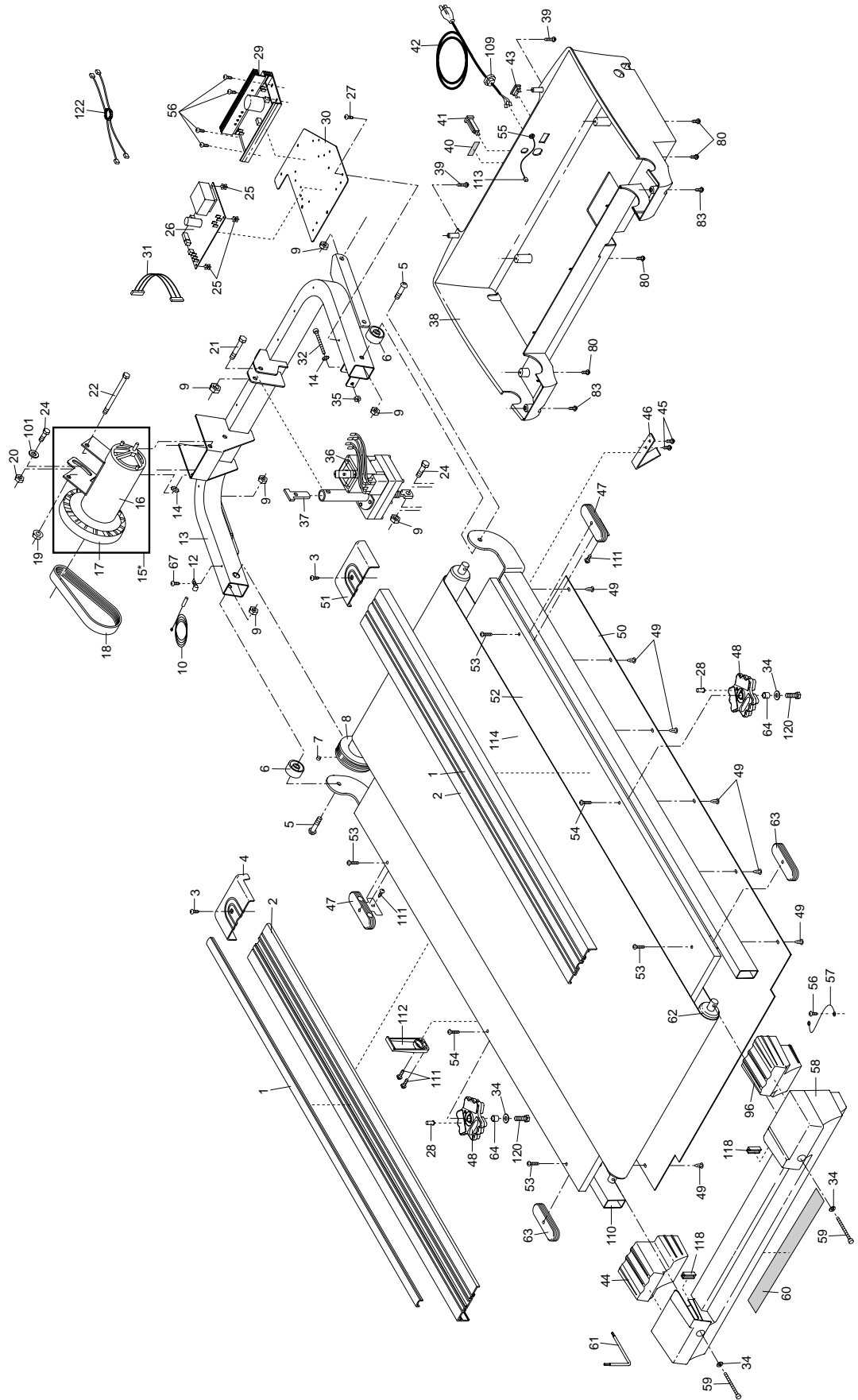

# EXPLODED DRAWING—Model No. PFTL99601

R0402A

