

# EXPLODED DRAWING—Model No. PFTL99602

R0804A

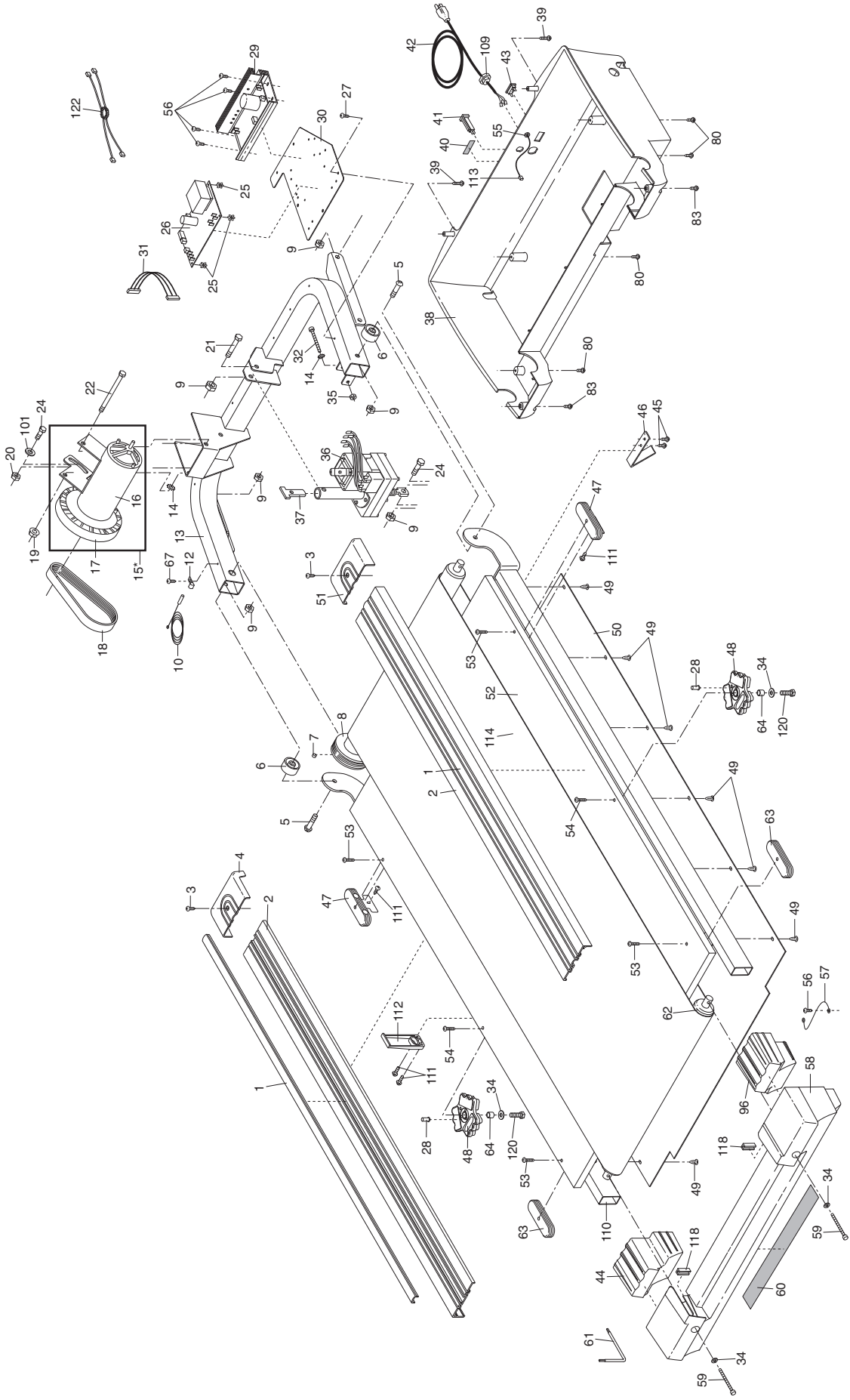

# EXPLODED DRAWING—Model No. PFTL99602

R0804A

