

EXPLODED DRAWING A

Model No. PFTL99612.0 R0812B

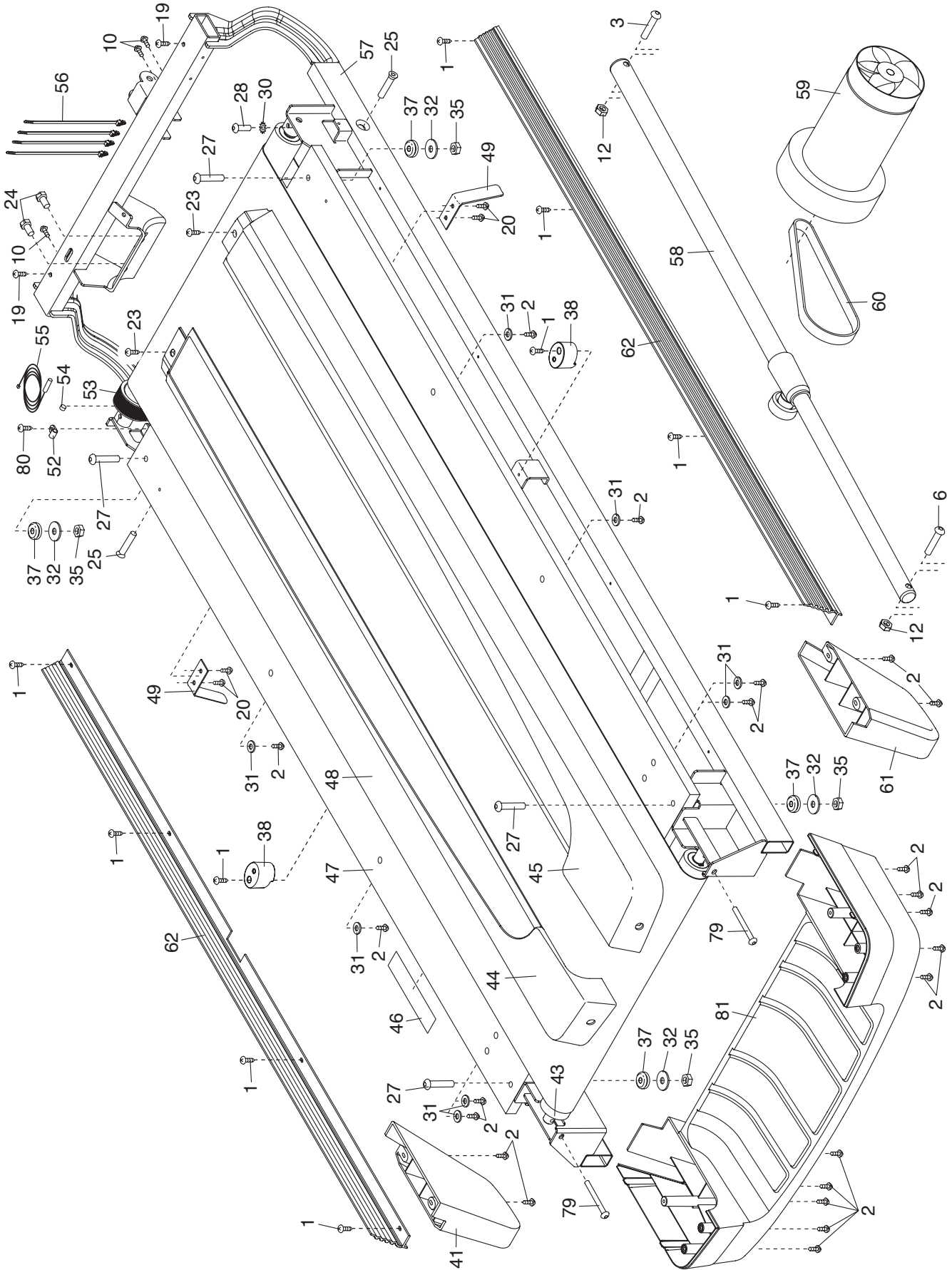

EXPLODED DRAWING B

Model No. PFTL99612.0 R0812B

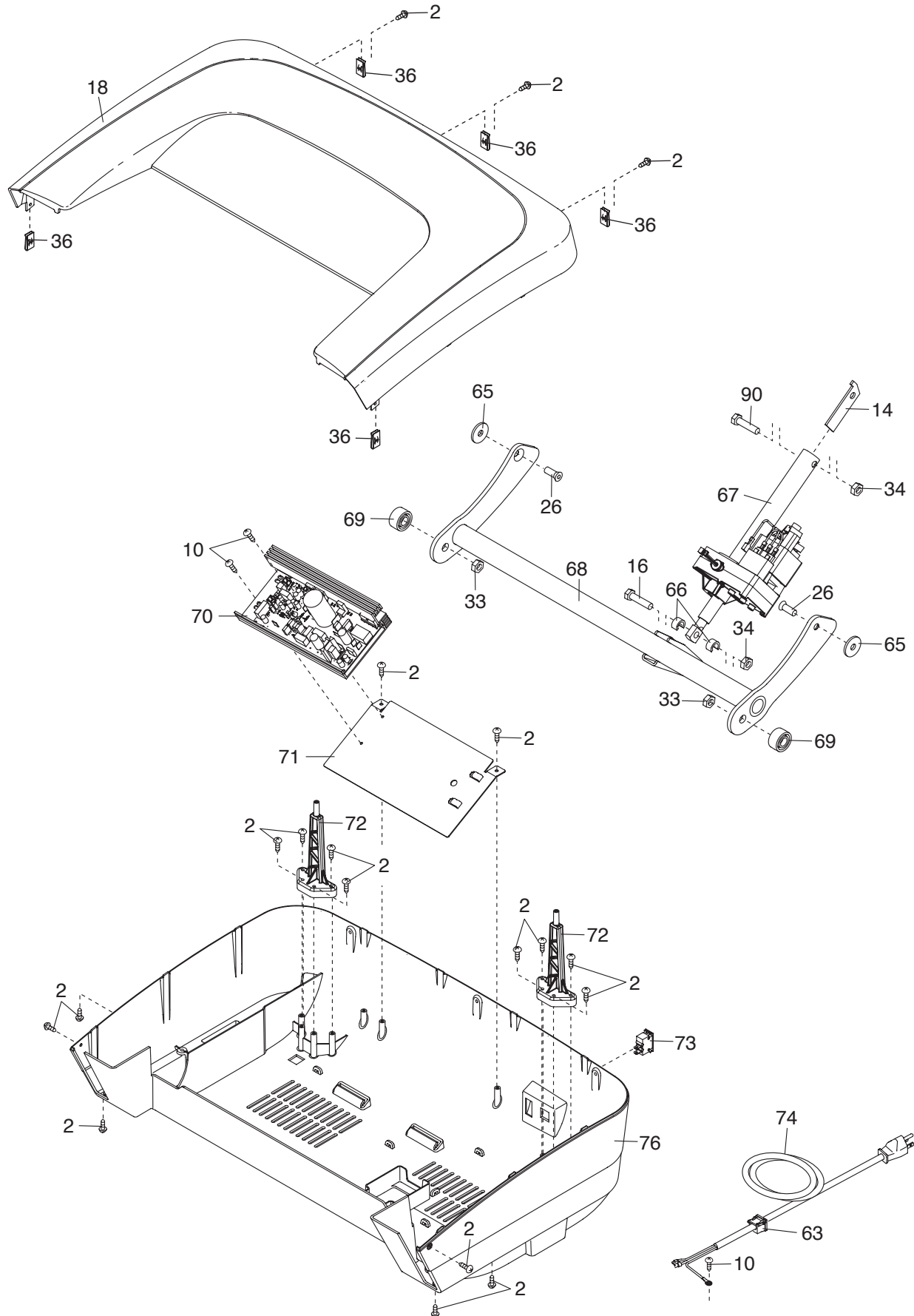

EXPLODED DRAWING C

Model No. PFTL99612.0 R0812B

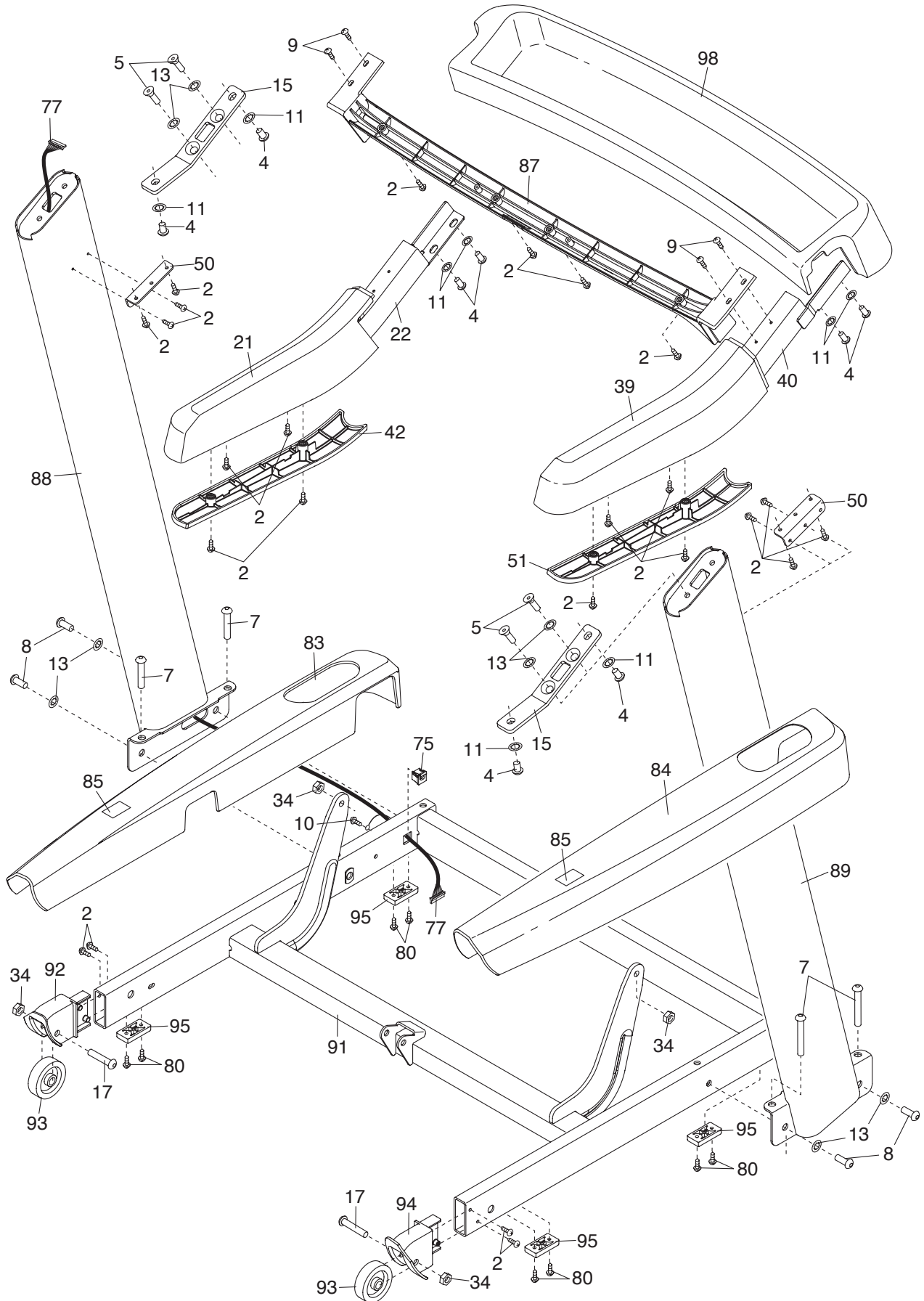

EXPLODED DRAWING D

Model No. PFTL99612.0 R0812B

