

EXPLODED DRAWING B—Model No. PFTL99707.0

R1107A

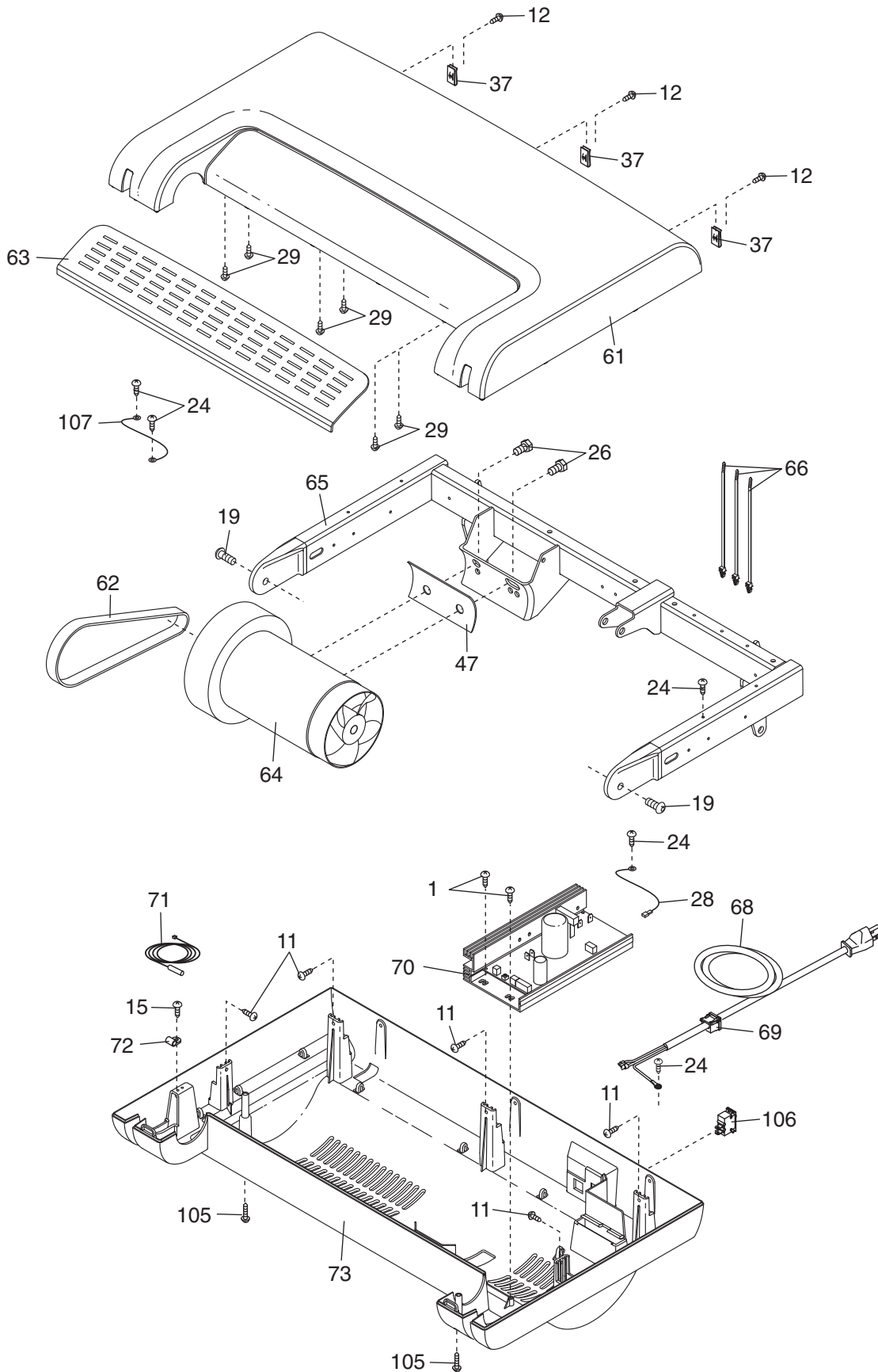

EXPLODED DRAWING C—Model No. PFTL99707.0

R1107A

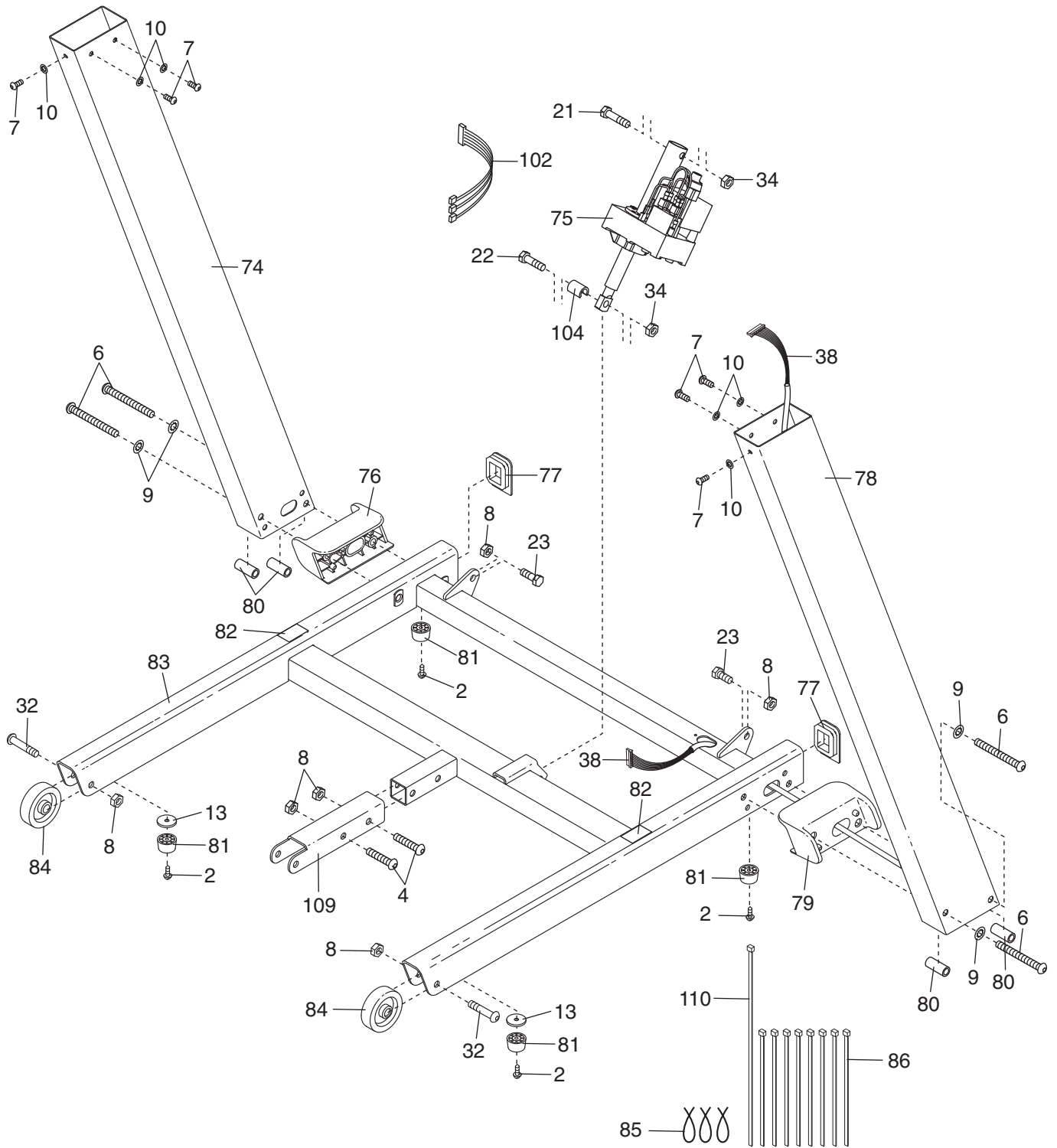

EXPLODED DRAWING D—Model No. PFTL99707.0

R1107A

