

EXPLODED DRAWING B

Model No. PFTL99715.3 R1216A

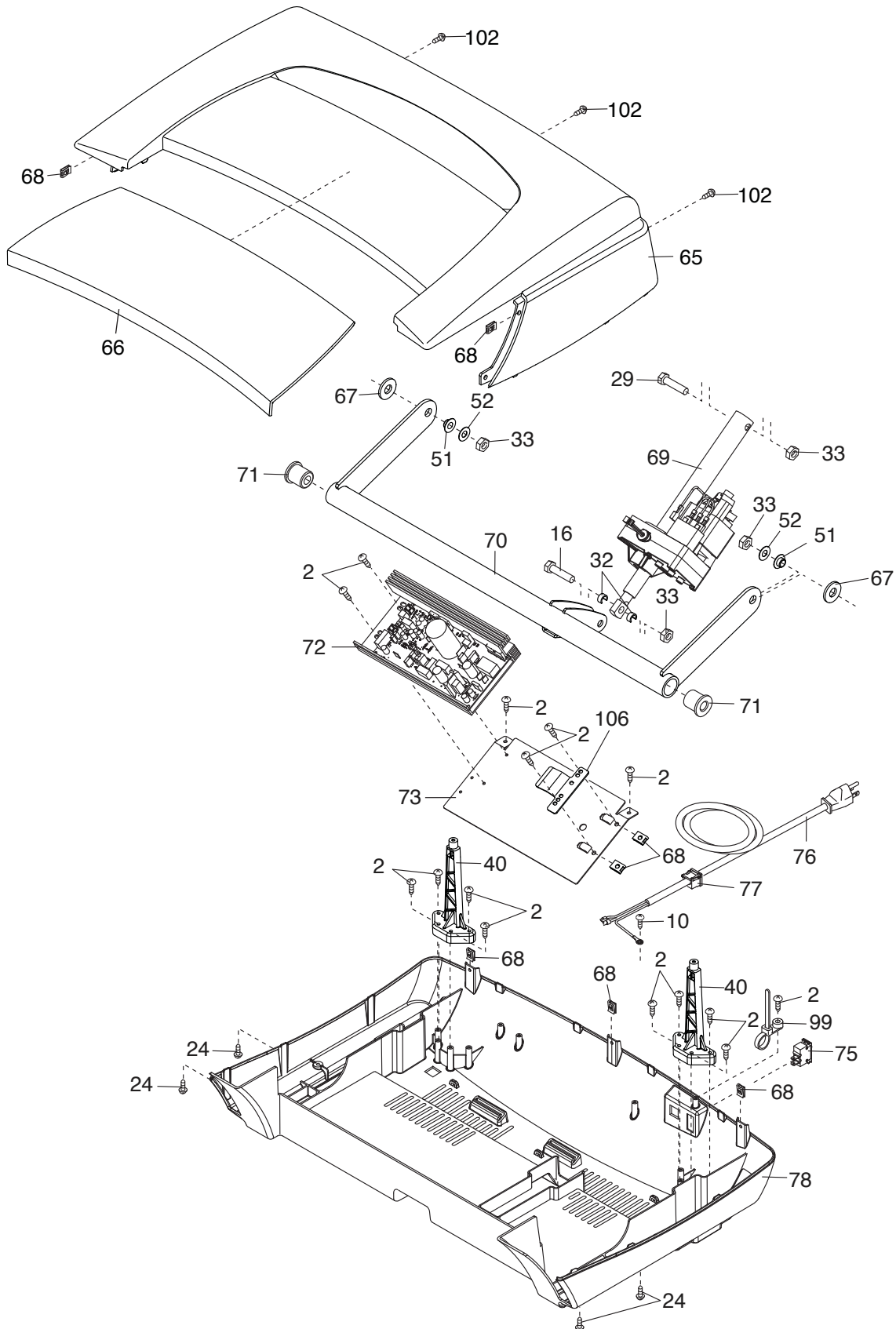

EXPLODED DRAWING C

Model No. PFTL99715.3 R1216A

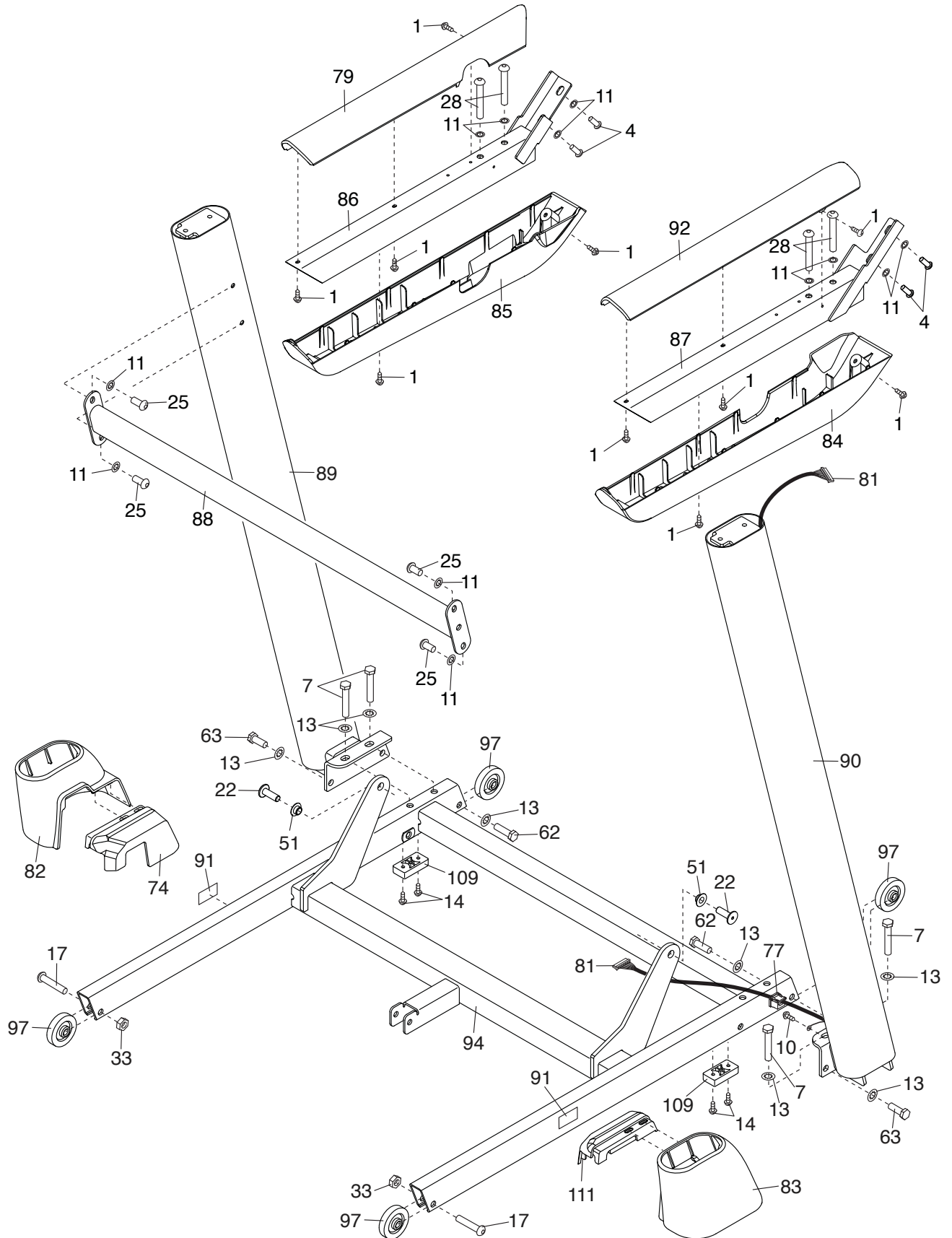

EXPLODED DRAWING D

Model No. PFTL99715.3 R1216A

