

EXPLODED DRAWING A

Model No. PFTL99715.1 R0915B

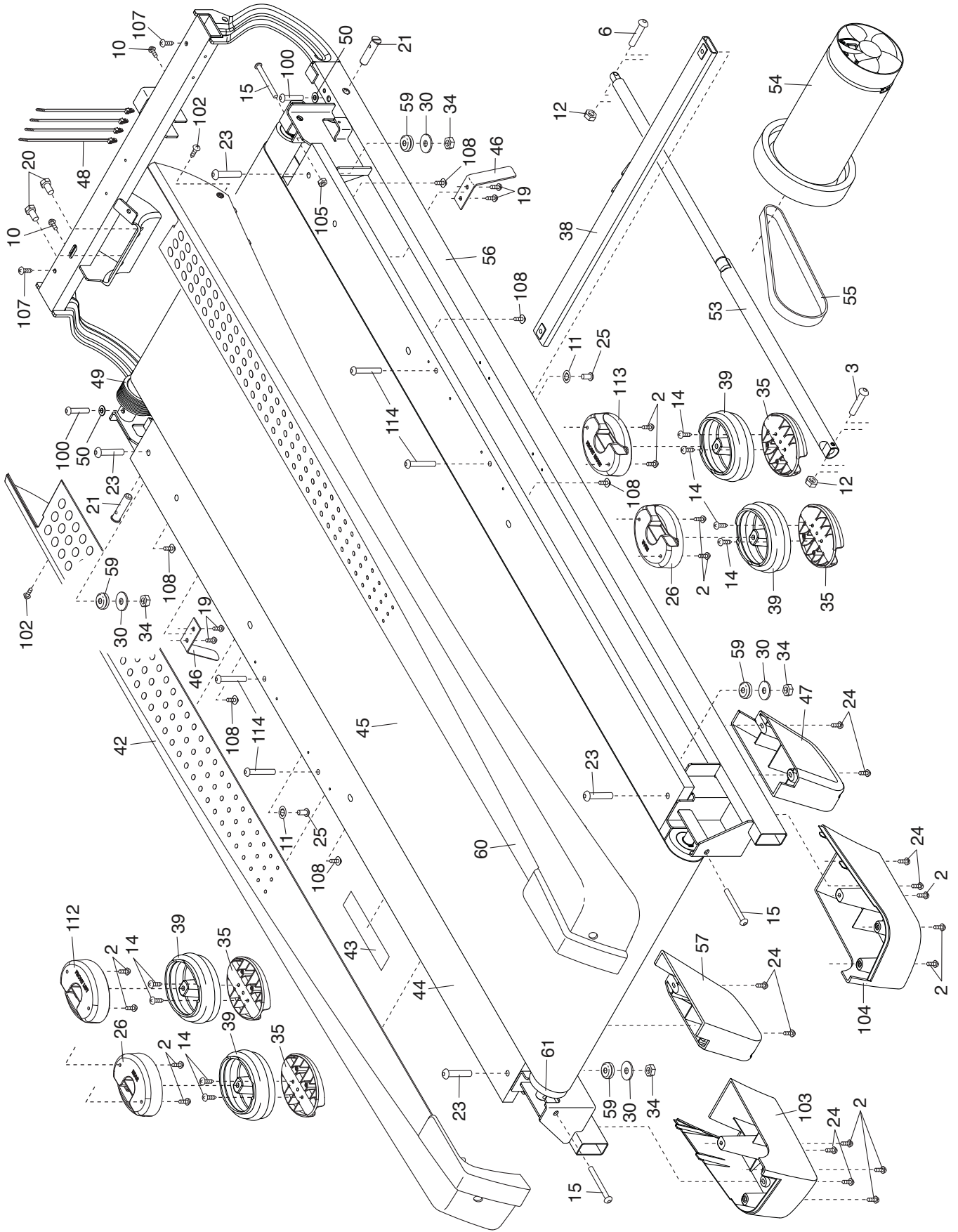

EXPLODED DRAWING B

Model No. PFTL99715.1 R0915B

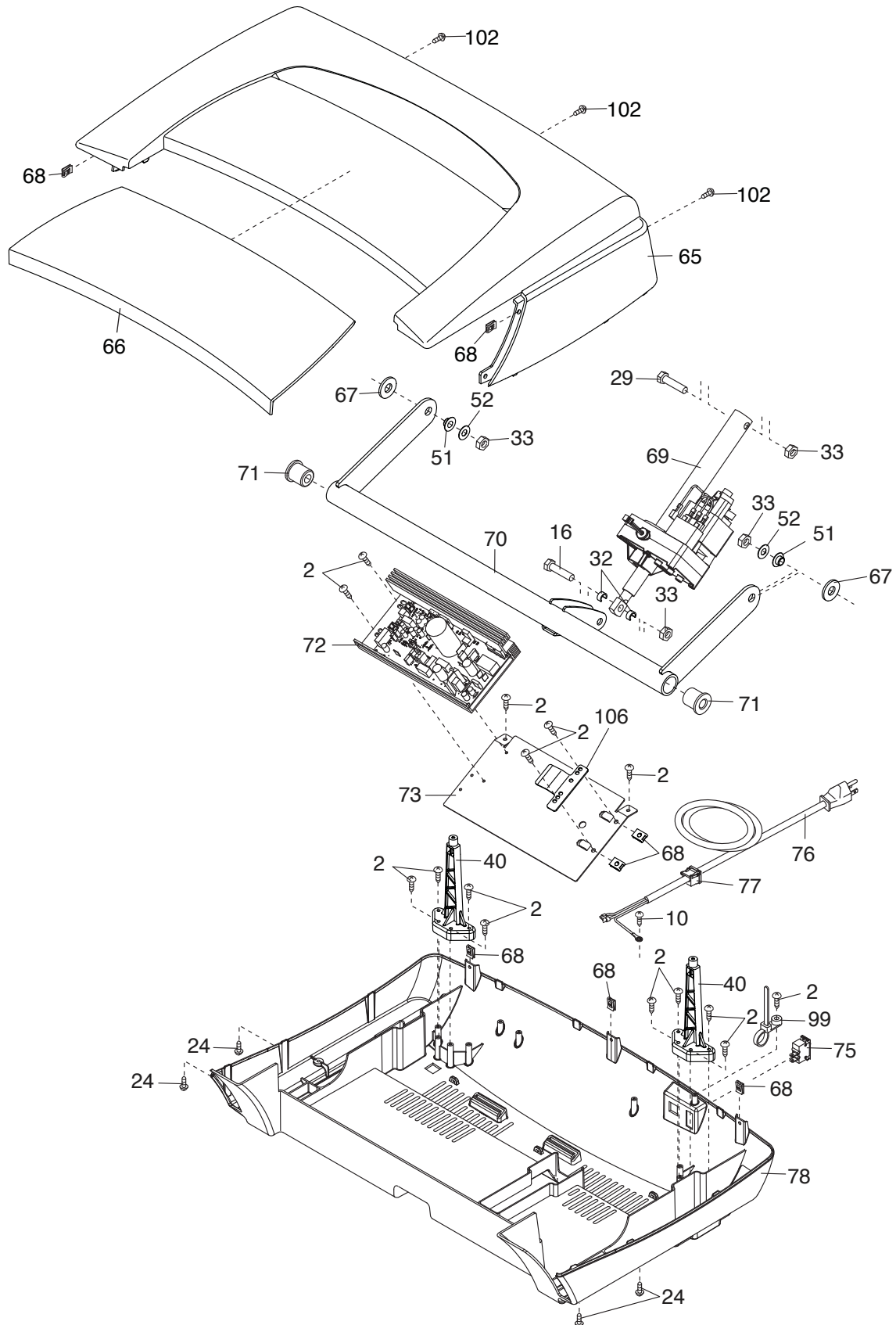

EXPLODED DRAWING C

Model No. PFTL99715.1 R0915B

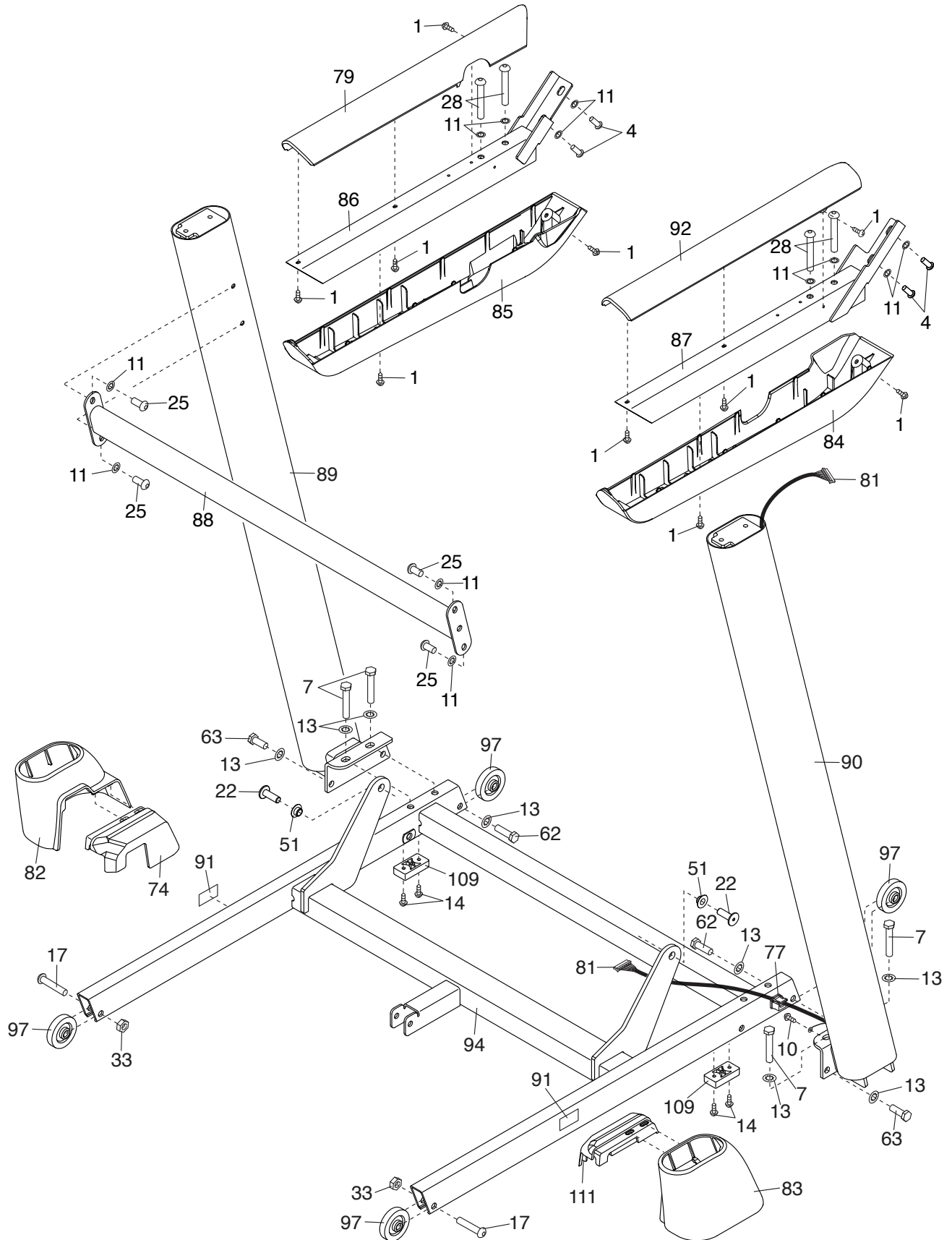

EXPLODED DRAWING D

Model No. PFTL99715.1 R0915B

