

# EXPLODED DRAWING A

Model No. PFTL99715.6 R0318A

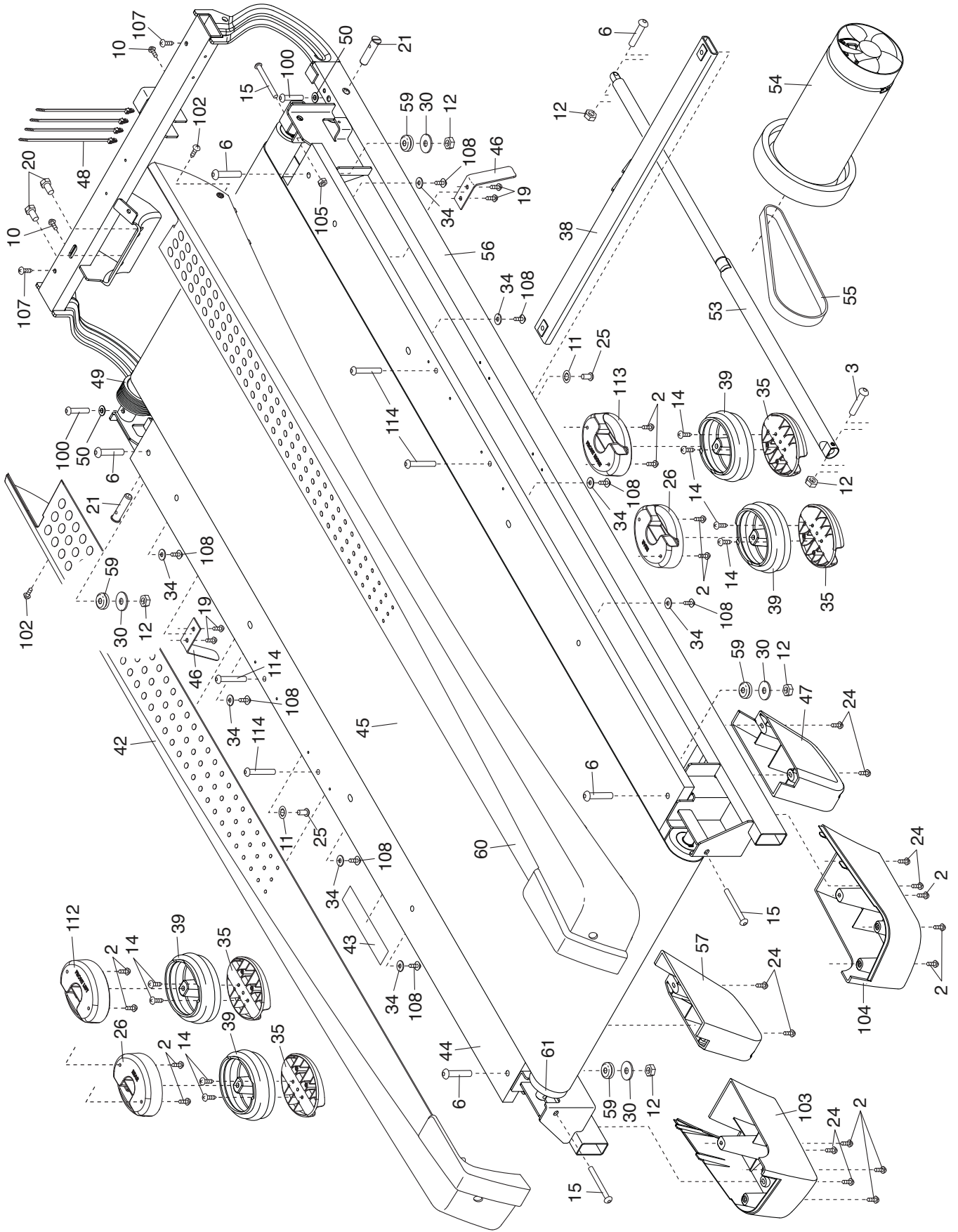

# EXPLODED DRAWING B

Model No. PFTL99715.6 R0318A

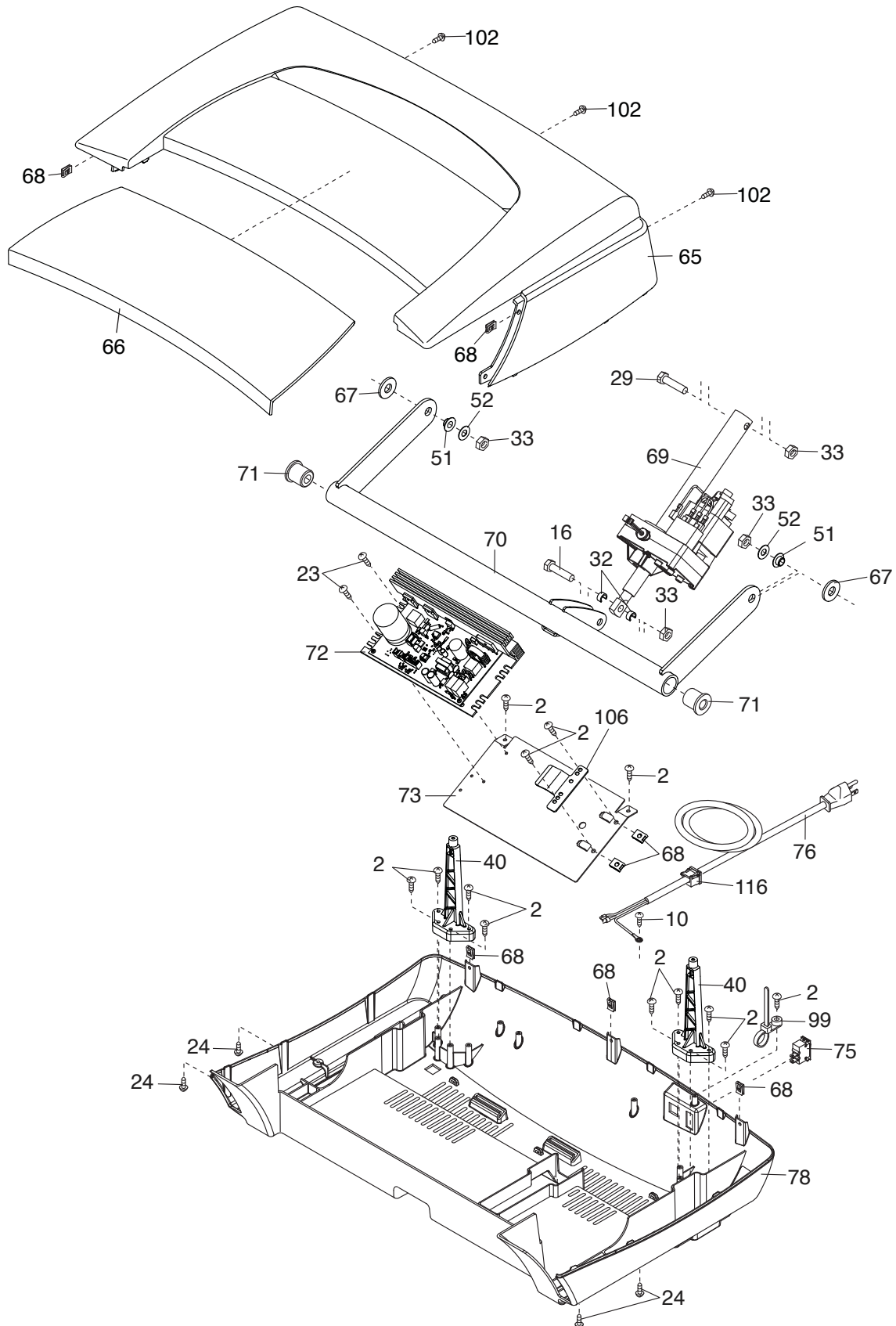

# EXPLODED DRAWING C

Model No. PFTL99715.6 R0318A

