

# EXPLODED DRAWING A

Model No. PFTL99721.0 R0121A

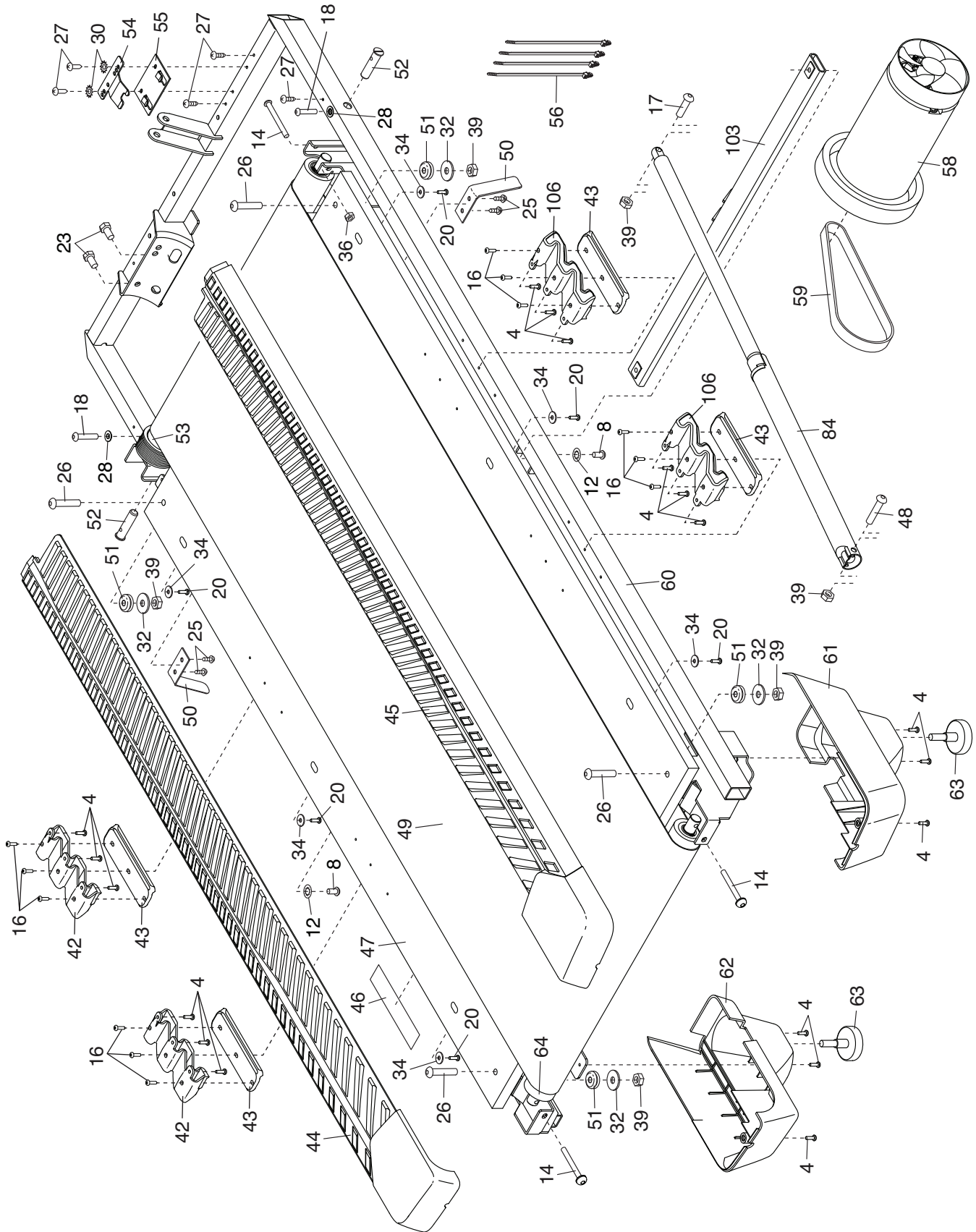

# EXPLODED DRAWING B

Model No. PFTL99721.0 R0121A

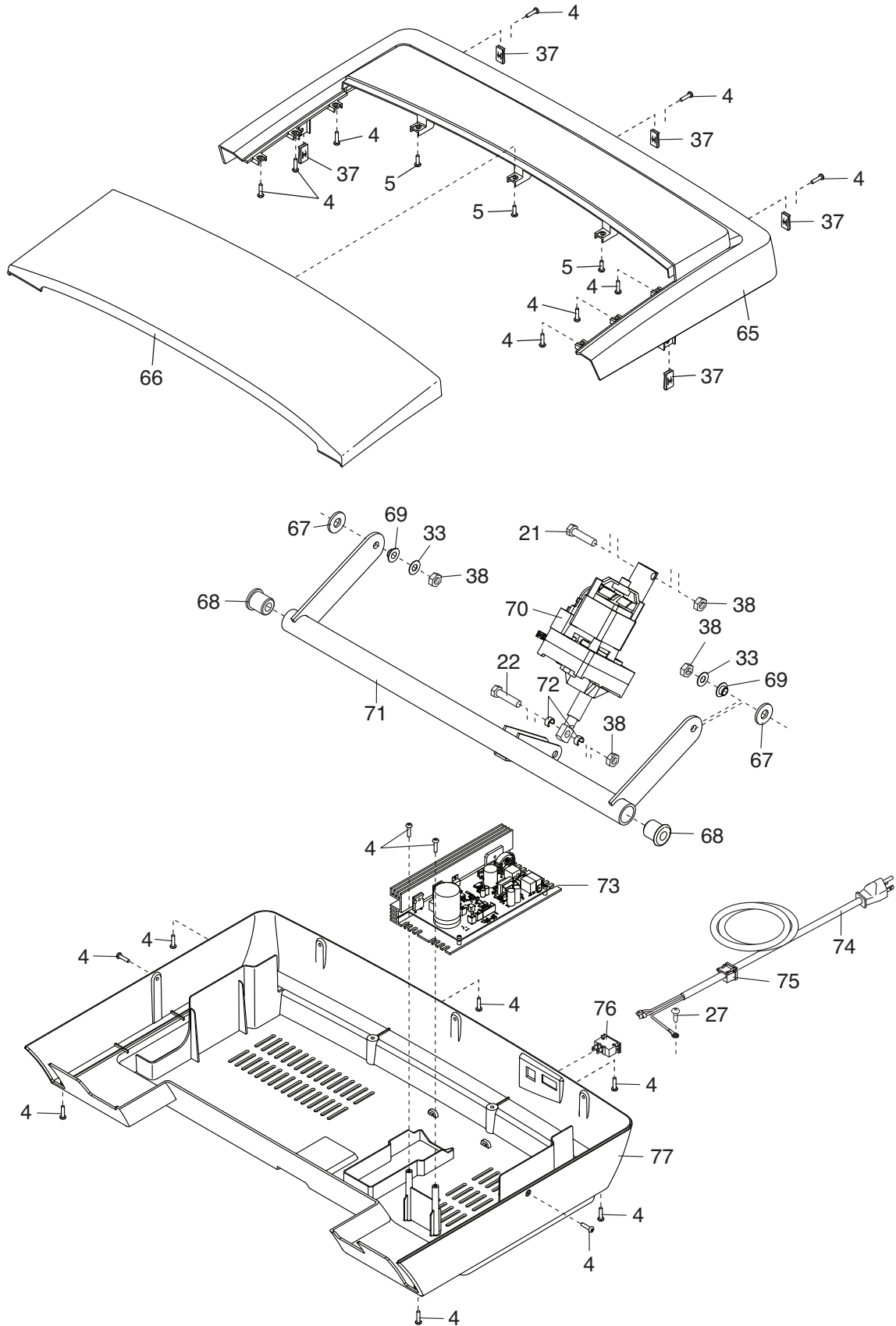

# EXPLODED DRAWING C

Model No. PFTL99721.0 R0121A

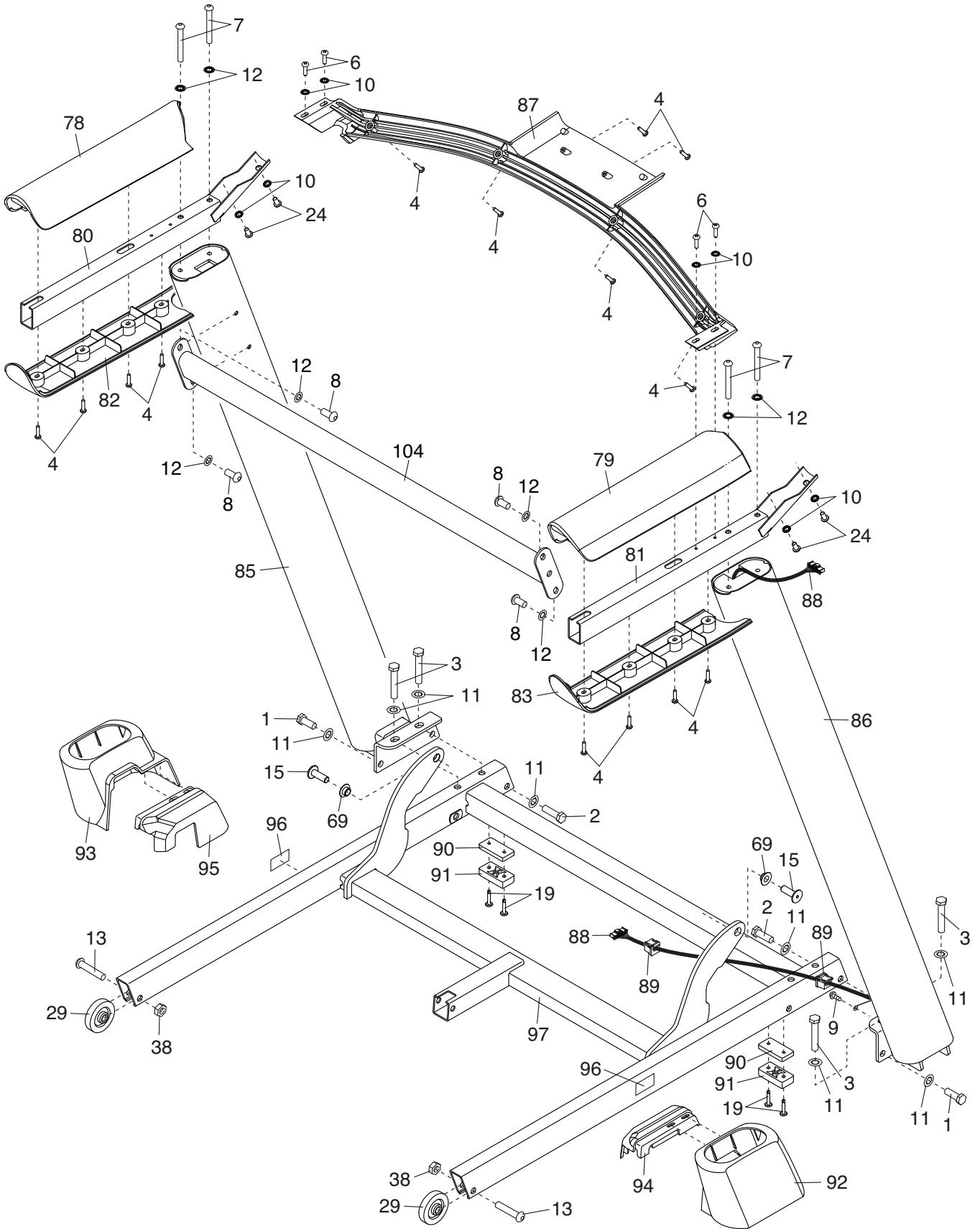

# EXPLODED DRAWING D

Model No. PFTL99721.0 R0121A

