

EXPLODED DRAWING A—Model No. PFTL99908.2

R0609A

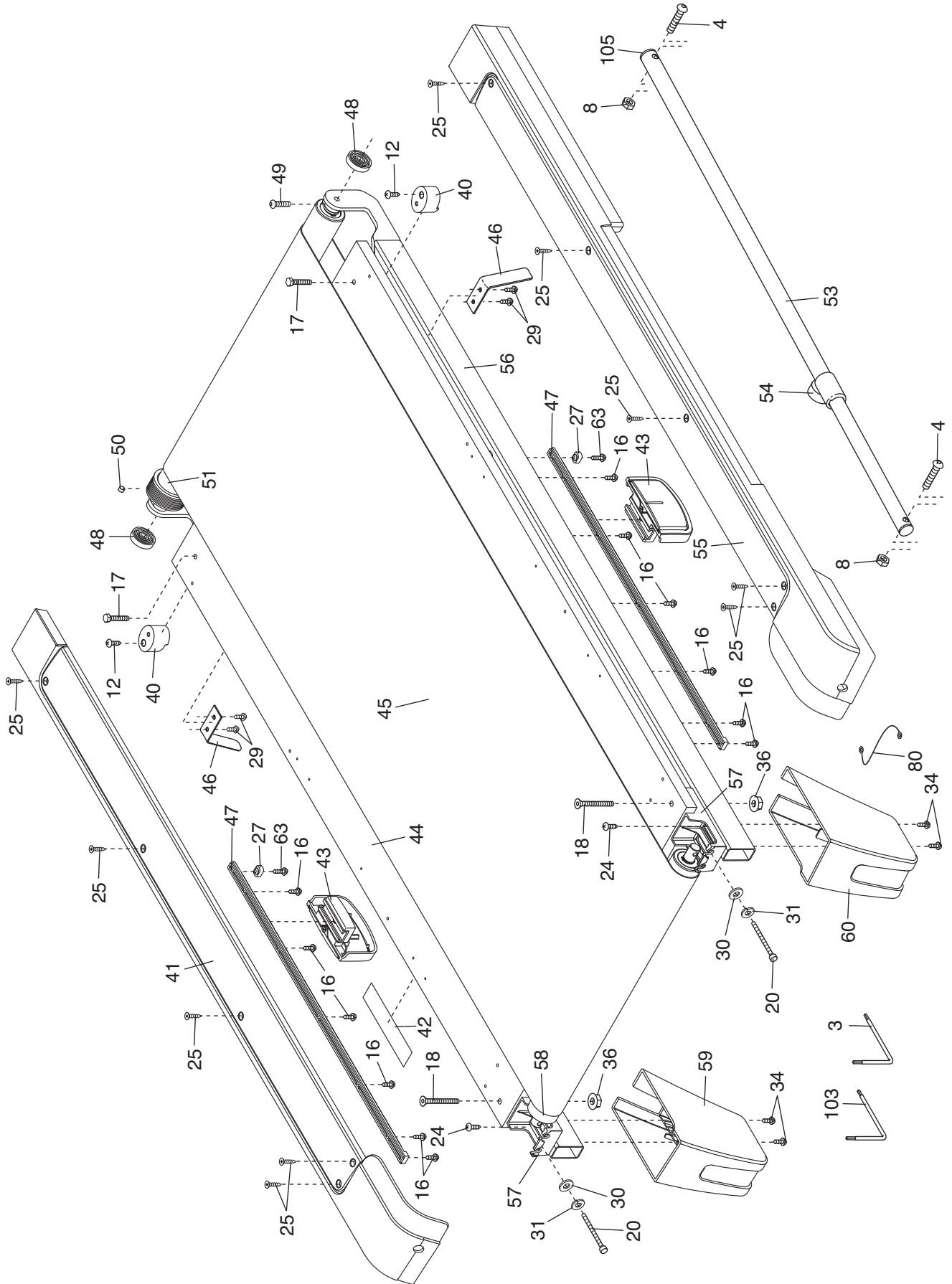

EXPLODED DRAWING B—Model No. PFTL99908.2

R0609A

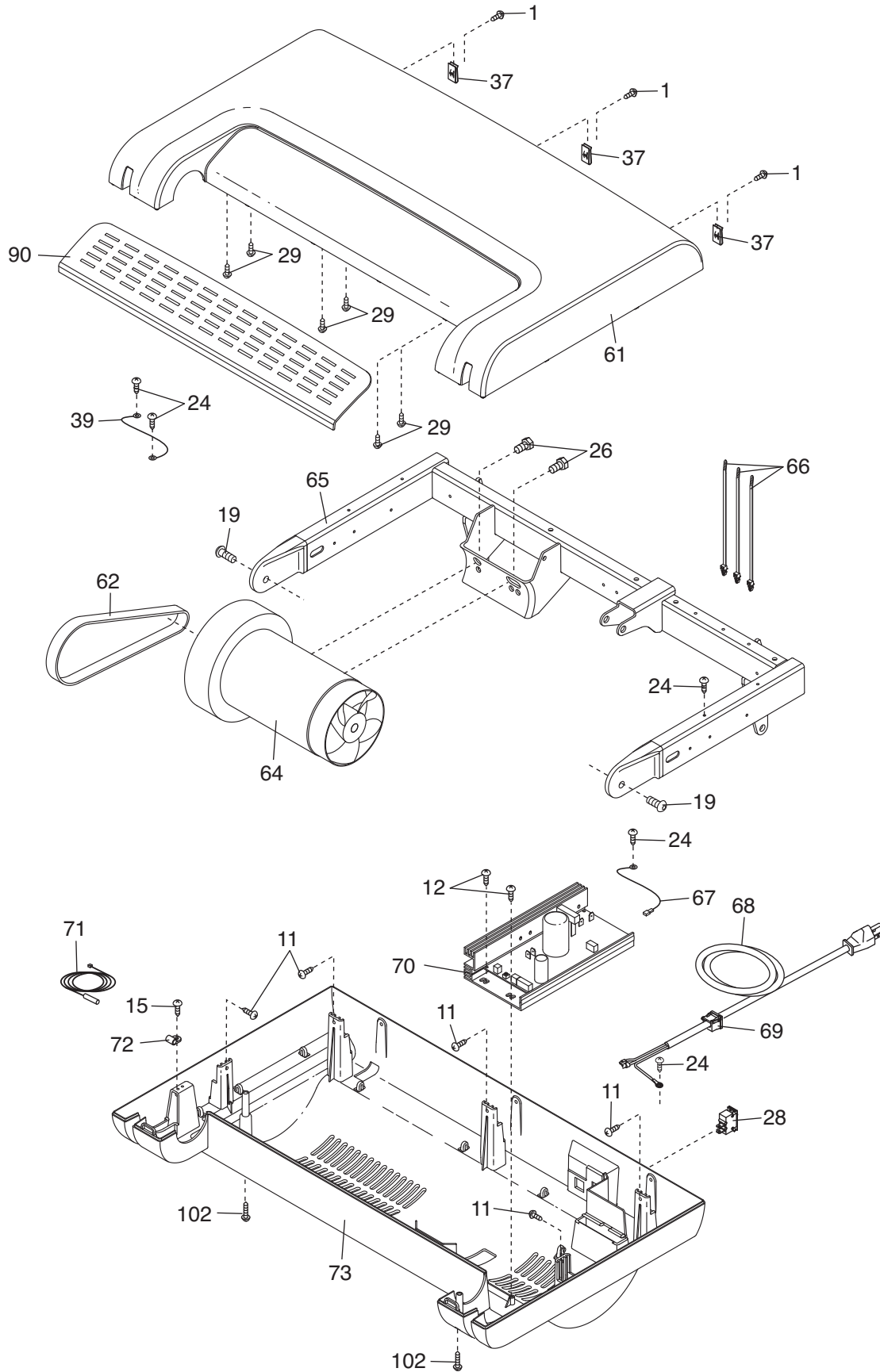

EXPLODED DRAWING C—Model No. PFTL99908.2

R0609A

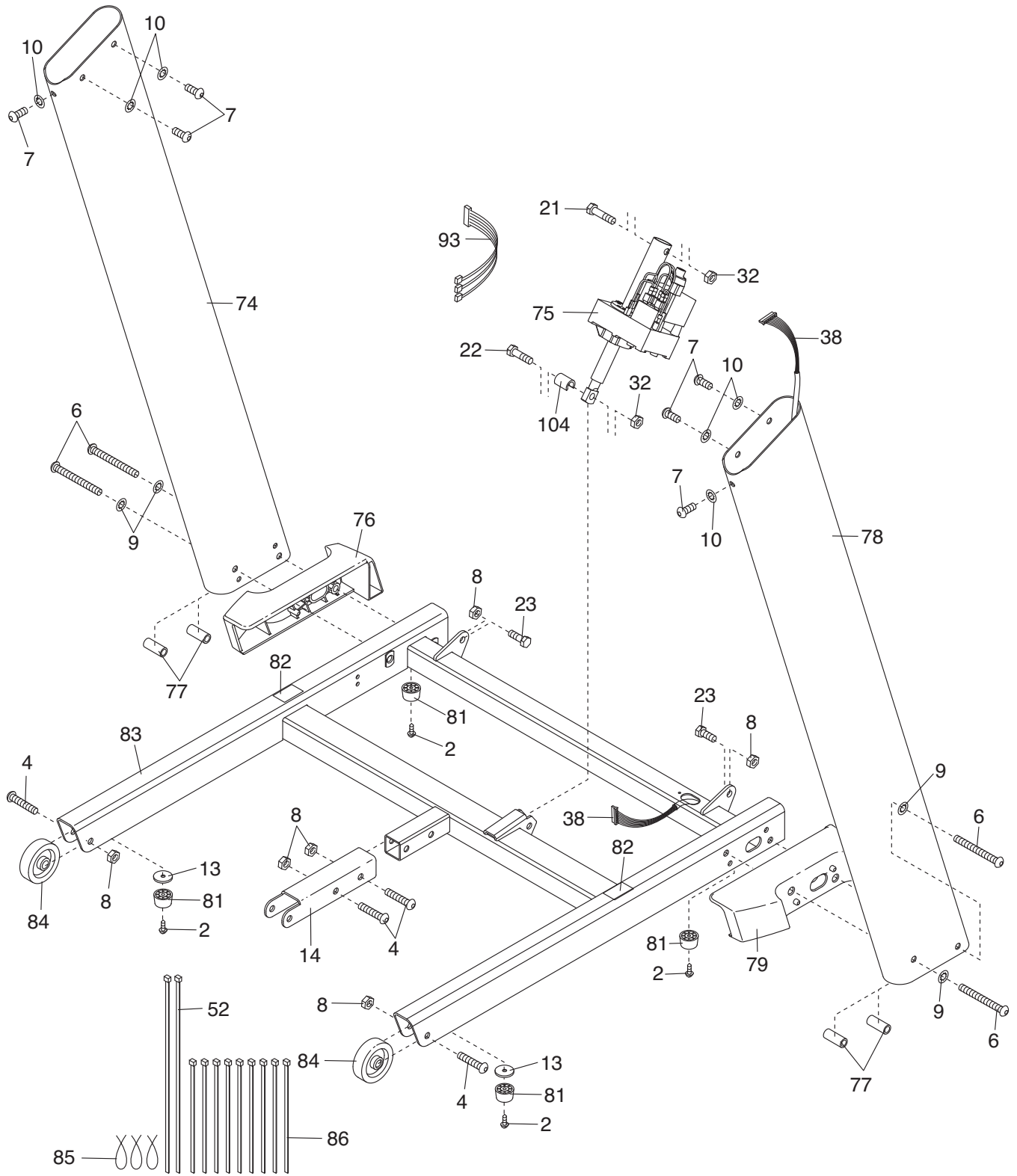

EXPLODED DRAWING D—Model No. PFTL99908.2

R0609A

