

# EXPLODED DRAWING A—Model No. PFTL99910.0

R1010A

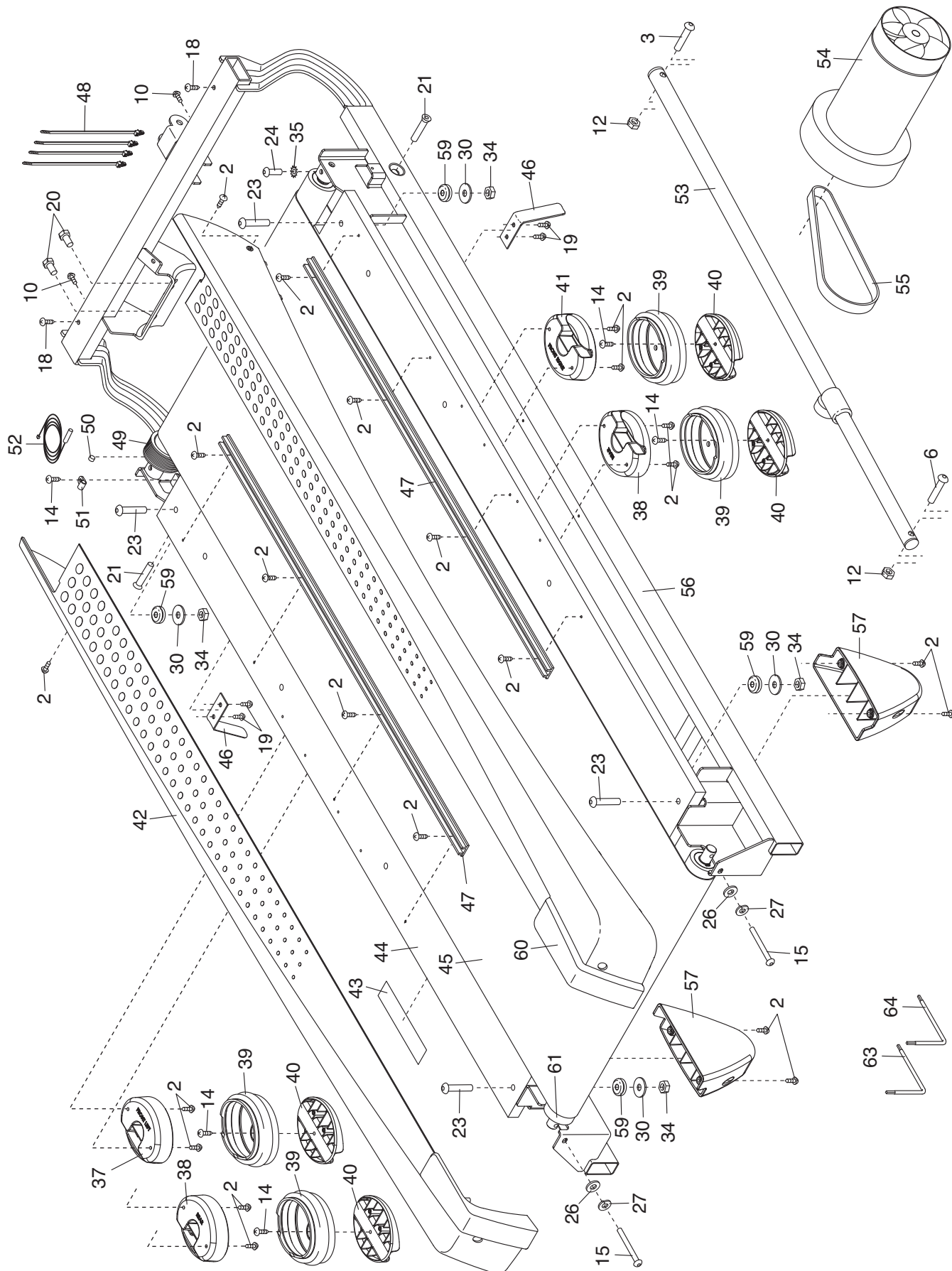

# EXPLODED DRAWING B—Model No. PFTL99910.0

R1010A

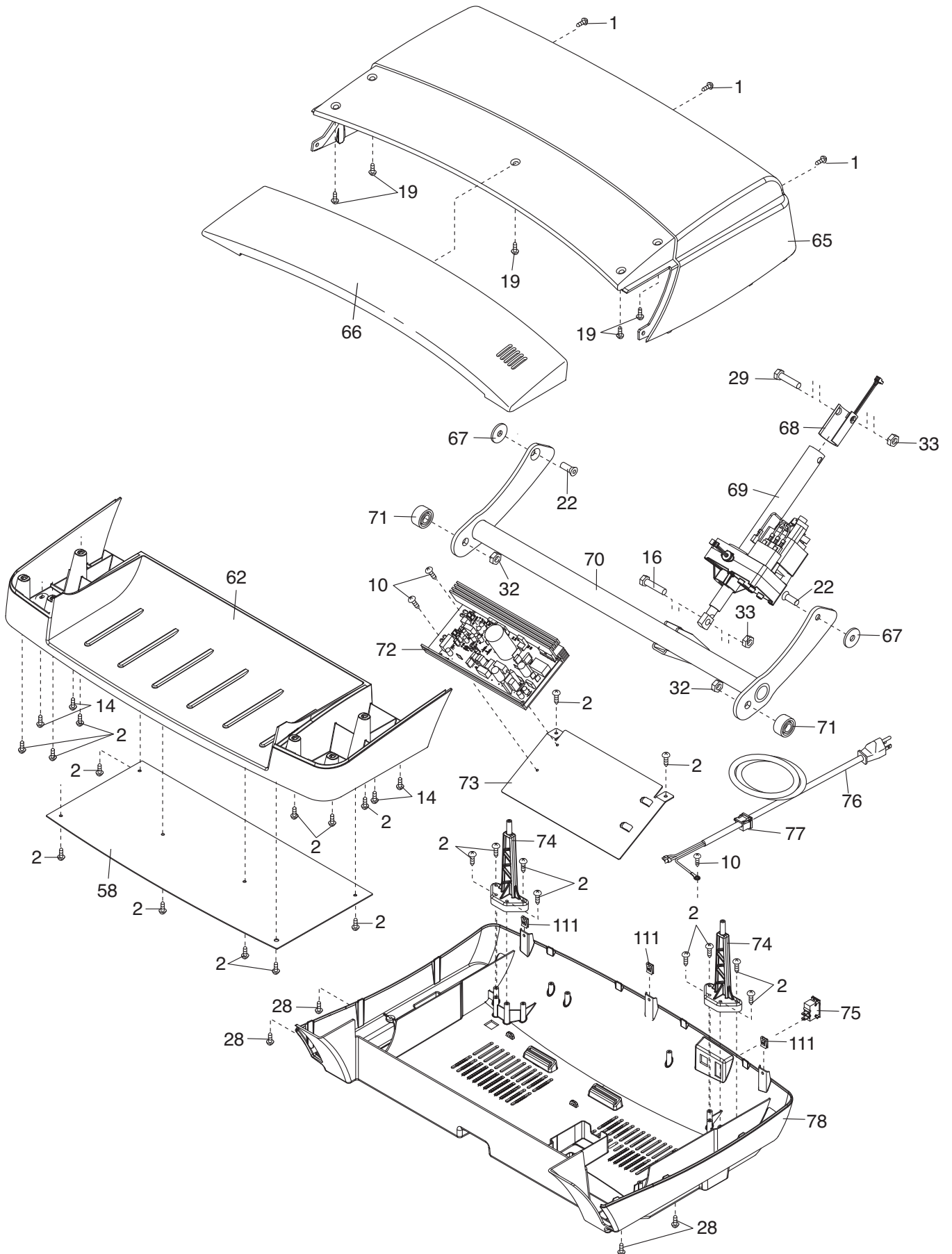

# EXPLODED DRAWING C—Model No. PFTL99910.0

R1010A

