

# EXPLODED DRAWING A

Model No. PFTL99911.0 R0212A

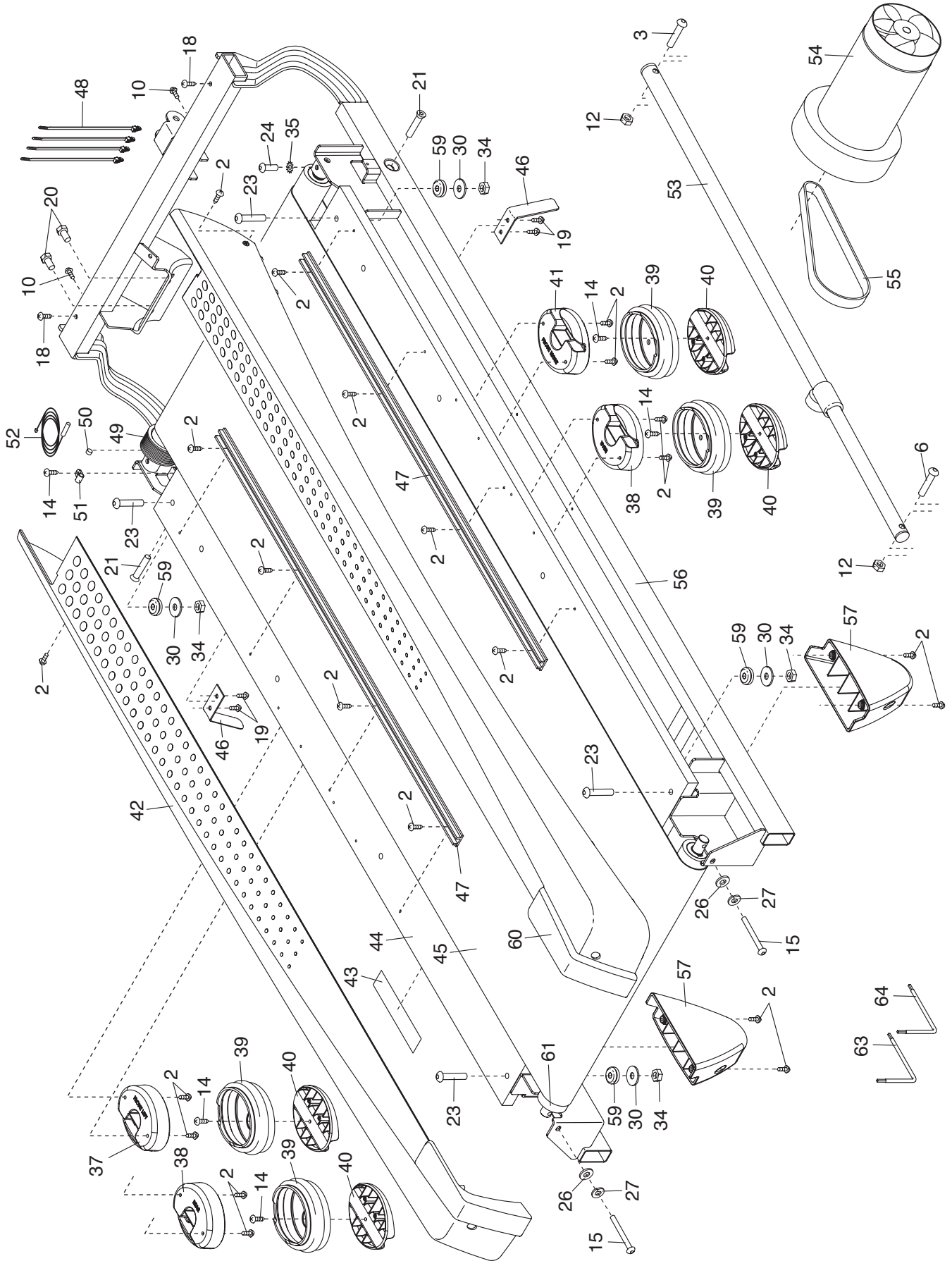



# EXPLODED DRAWING C

Model No. PFTL99911.0 R0212A

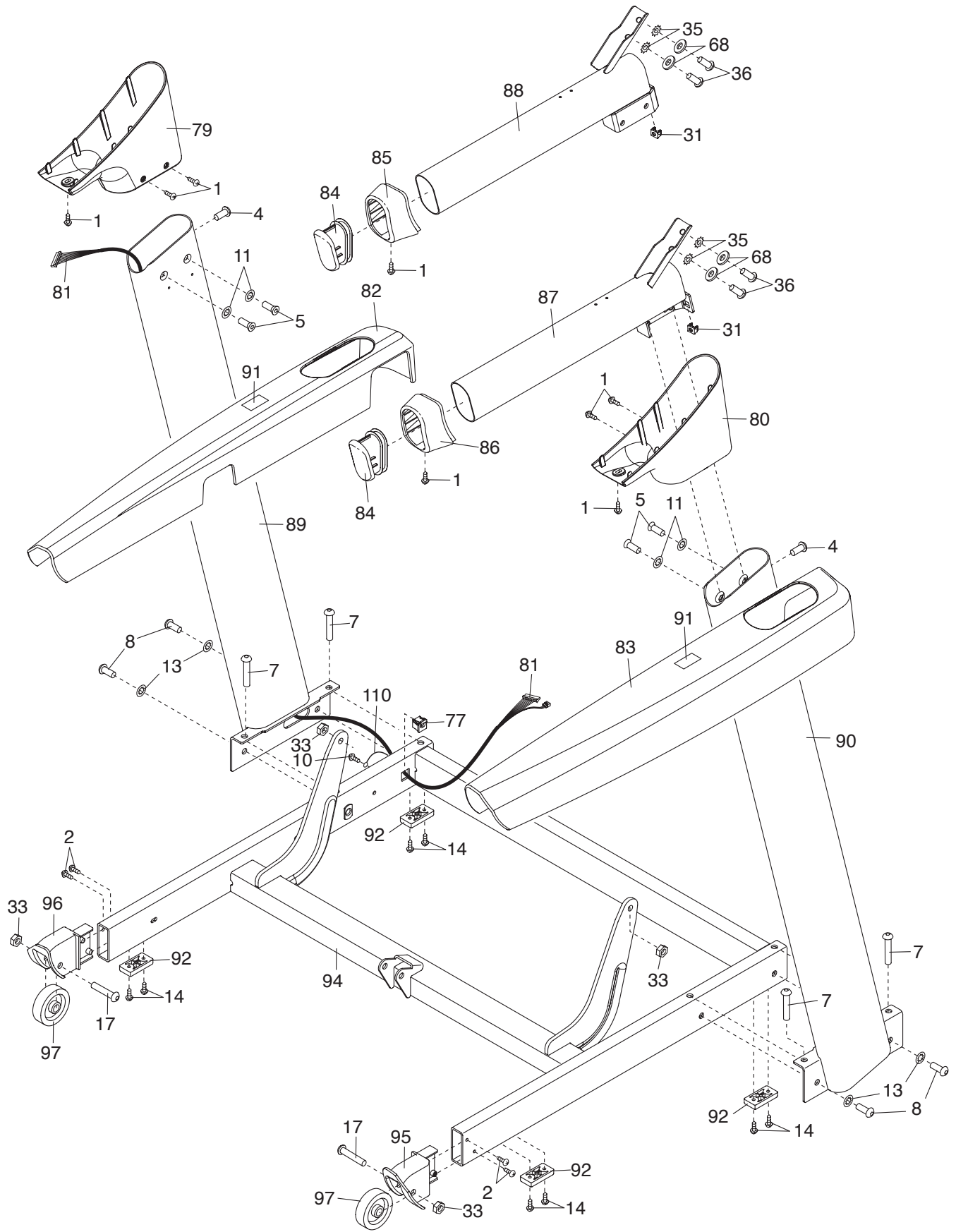

# EXPLODED DRAWING D

Model No. PFTL99911.0 R0212A

