

EXPLODED DRAWING A

Model No. PFTL99912.2 R0715A

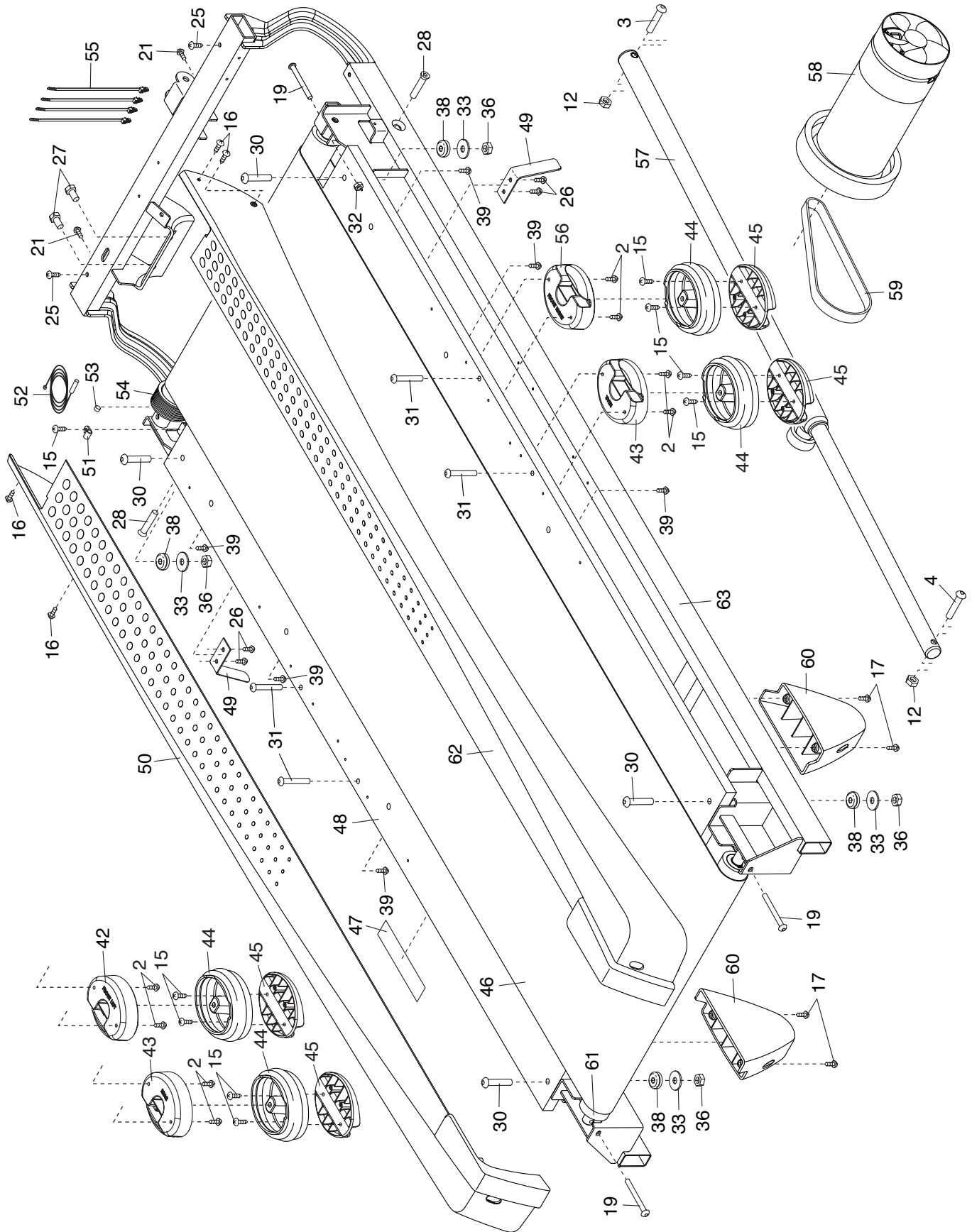

EXPLODED DRAWING B

Model No. PFTL99912.2 R0715A

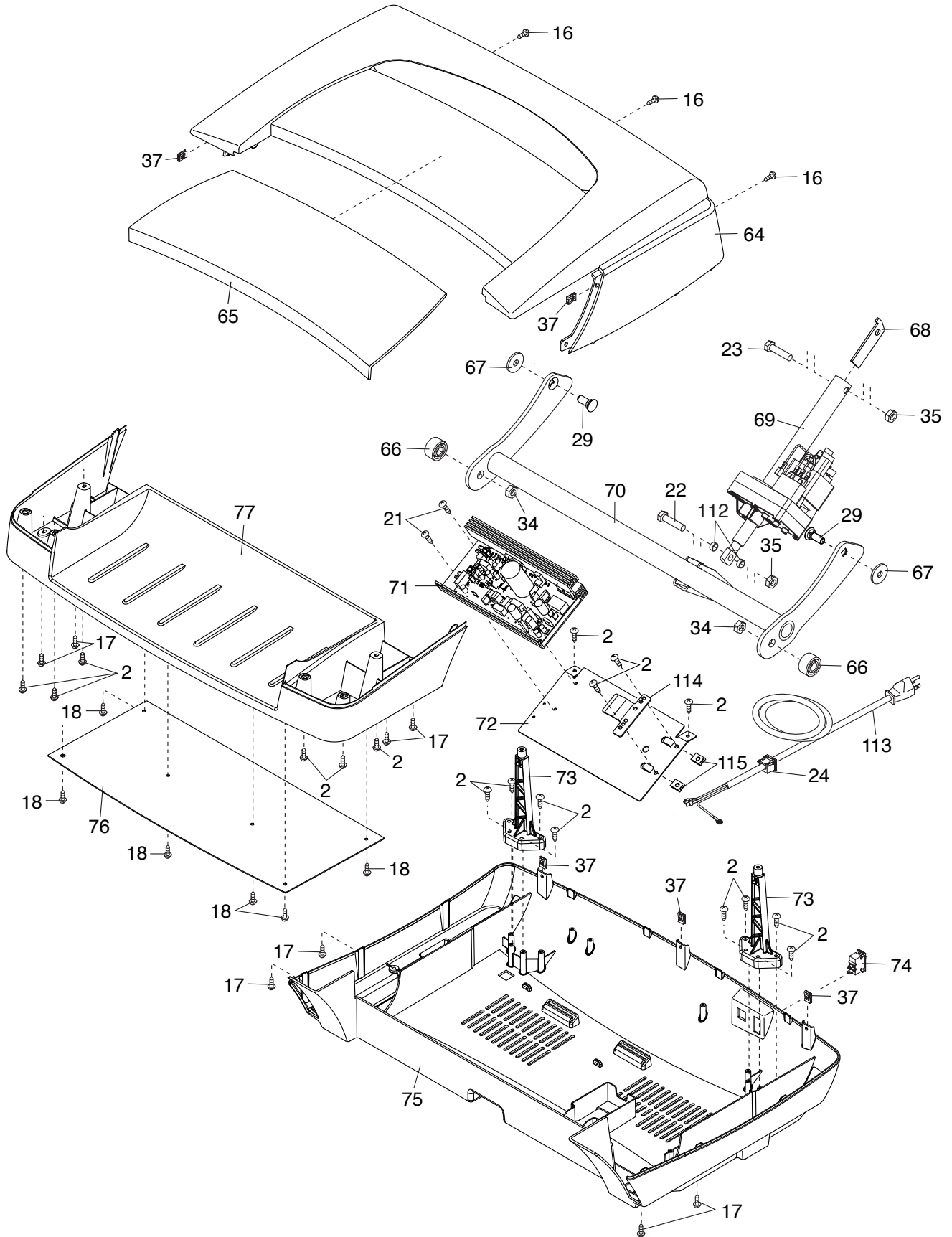

EXPLODED DRAWING D

Model No. PFTL99912.2 R0715A

