

EXPLODED DRAWING A

Model No. RBEL76010.1 R1011A

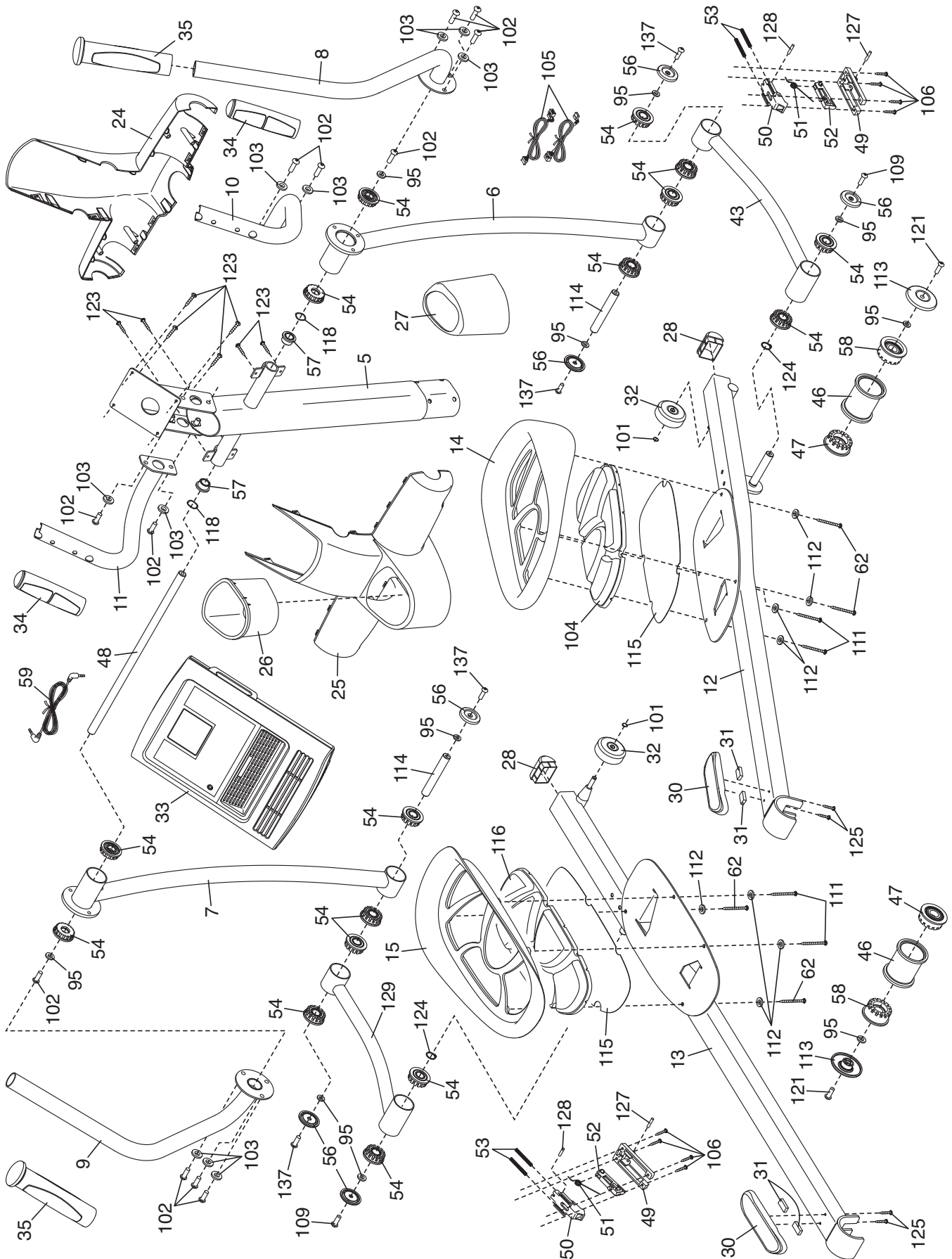

EXPLODED DRAWING B

Model No. RBEL76010.1 R1011A

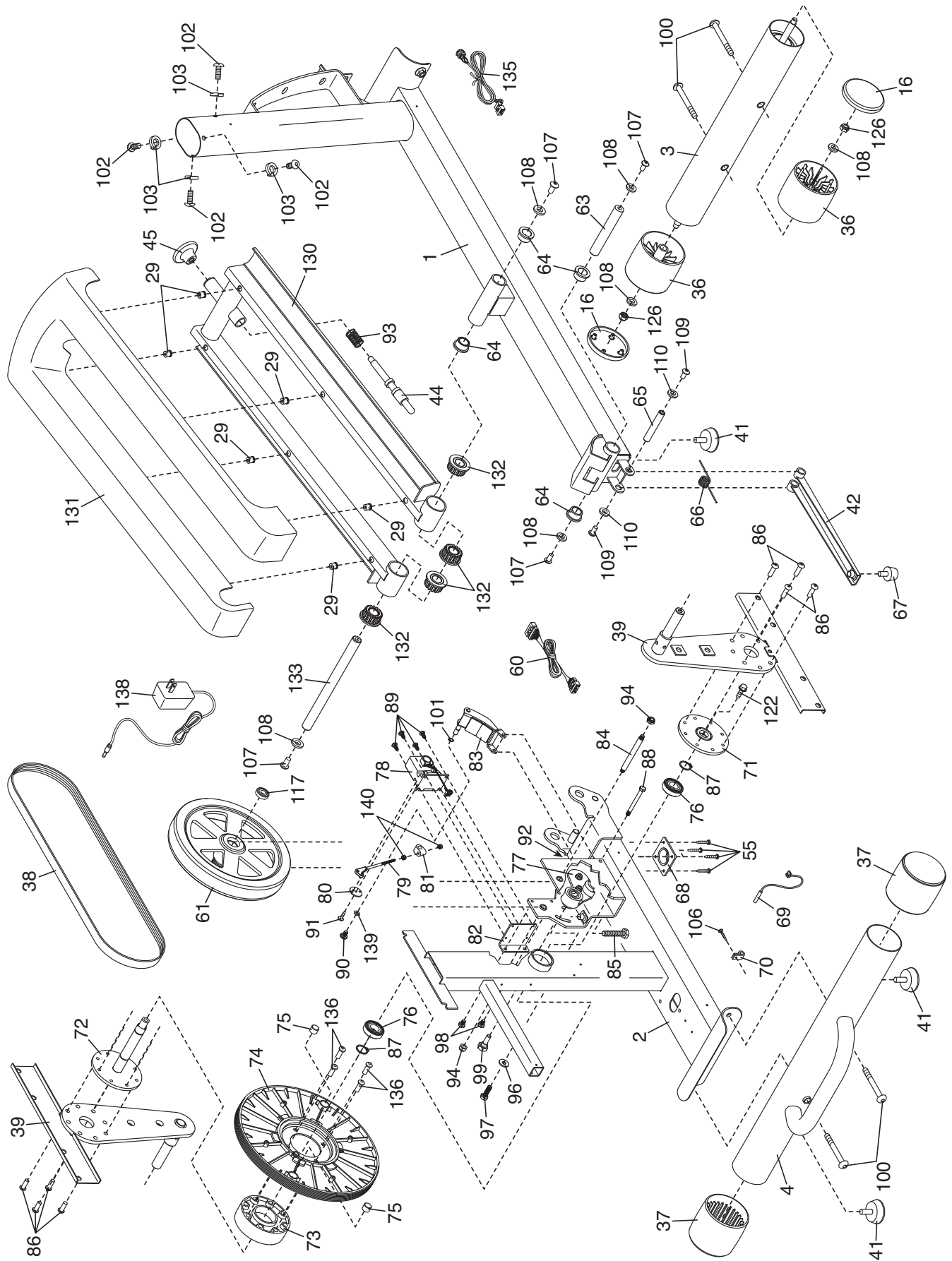

EXPLODED DRAWING C

Model No. RBEL76010.1 R1011A

