

EXPLODED DRAWING—MODEL NO. RBTL13910

R0502A

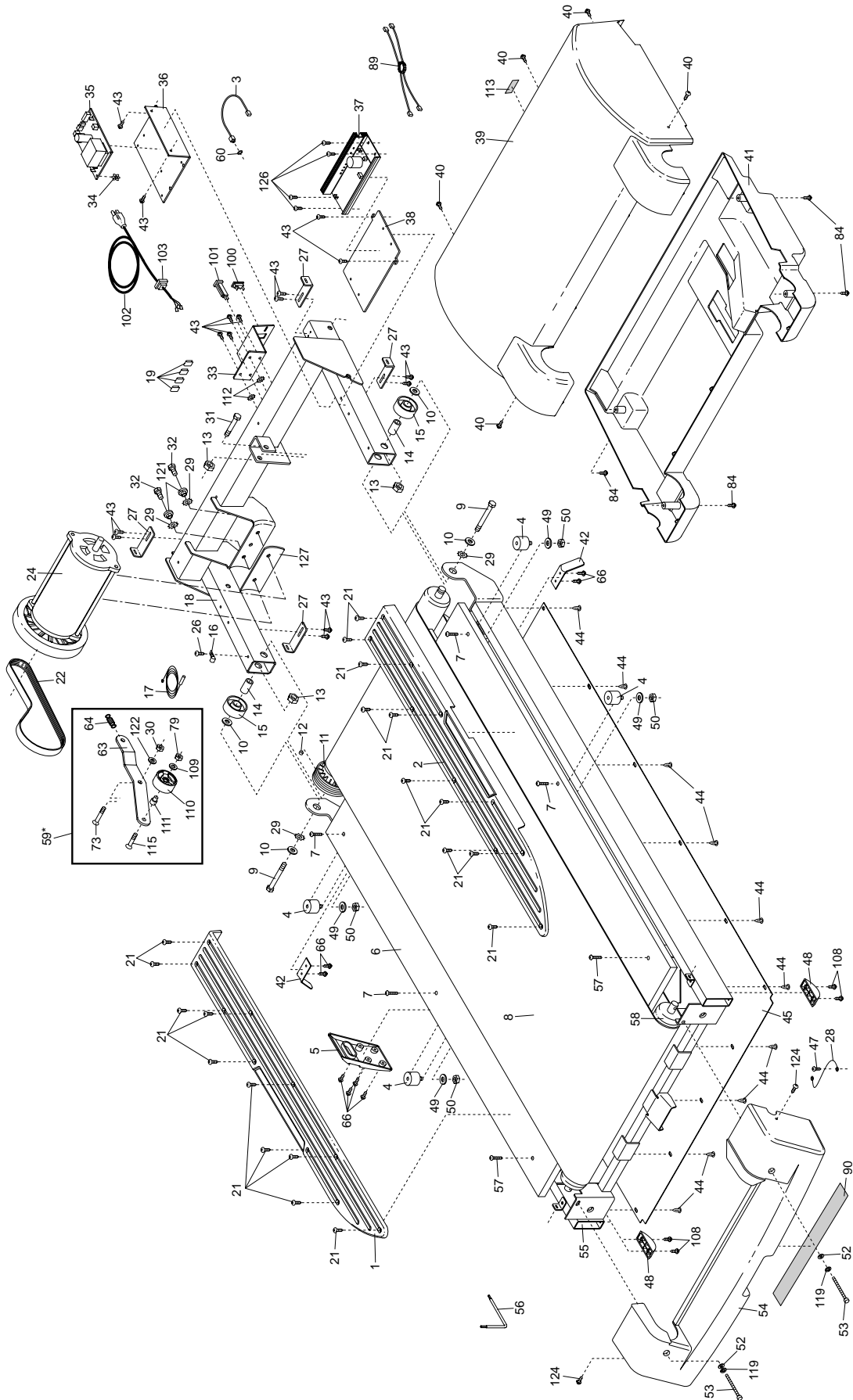

EXPLODED DRAWING—MODEL NO. RBTL13910

R0502A

