

EXPLODED DRAWING—Model No. RBTL14506.2

R0507A

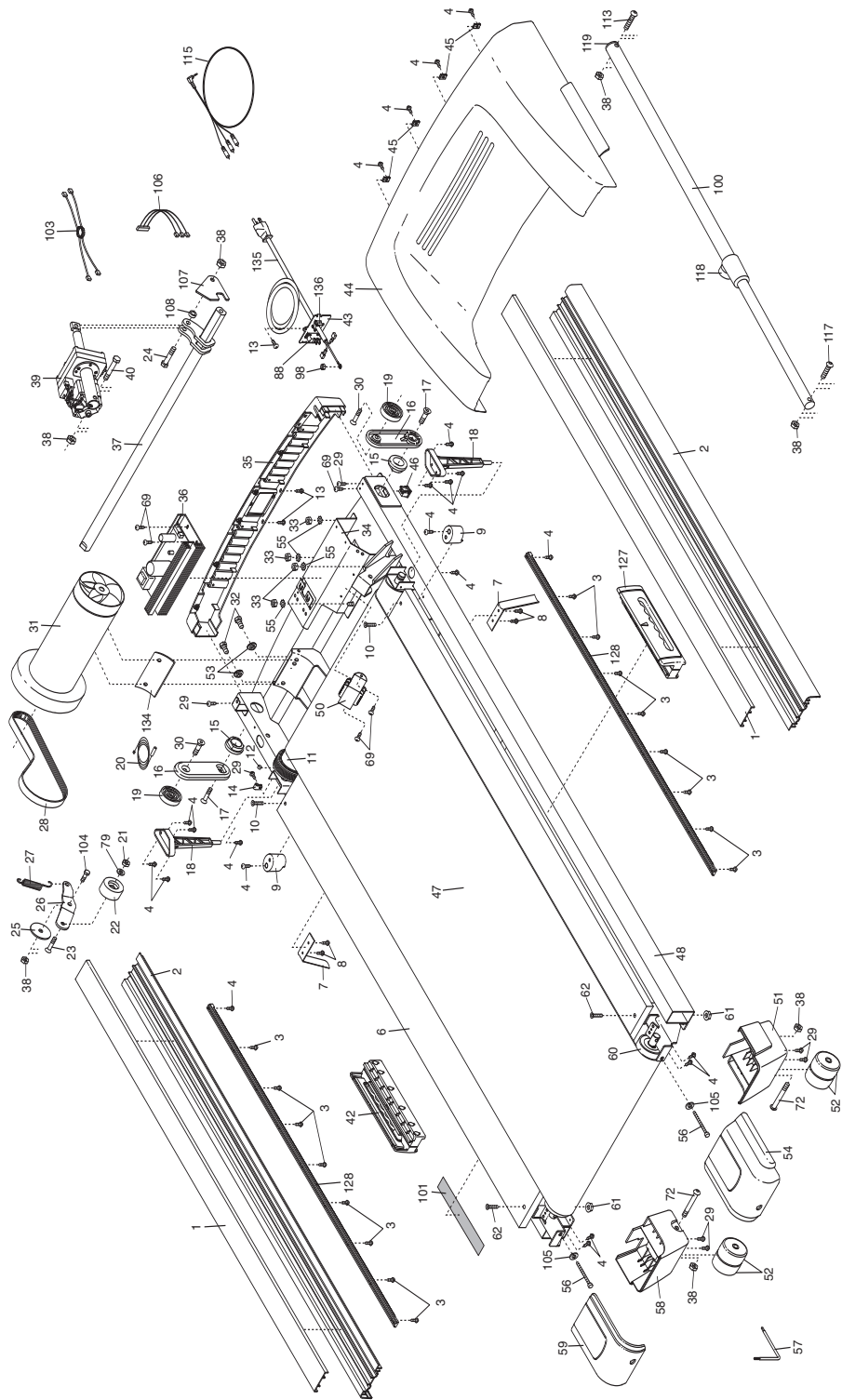

To identify the parts shown on this EXPLODED DRAWING, see the PART LIST on pages 30 and 31.

EXPLODED DRAWING—Model No. RBTL14506.2

R0507A

