

EXPLODED DRAWING—MODEL NO. RBTL14911

R0402A

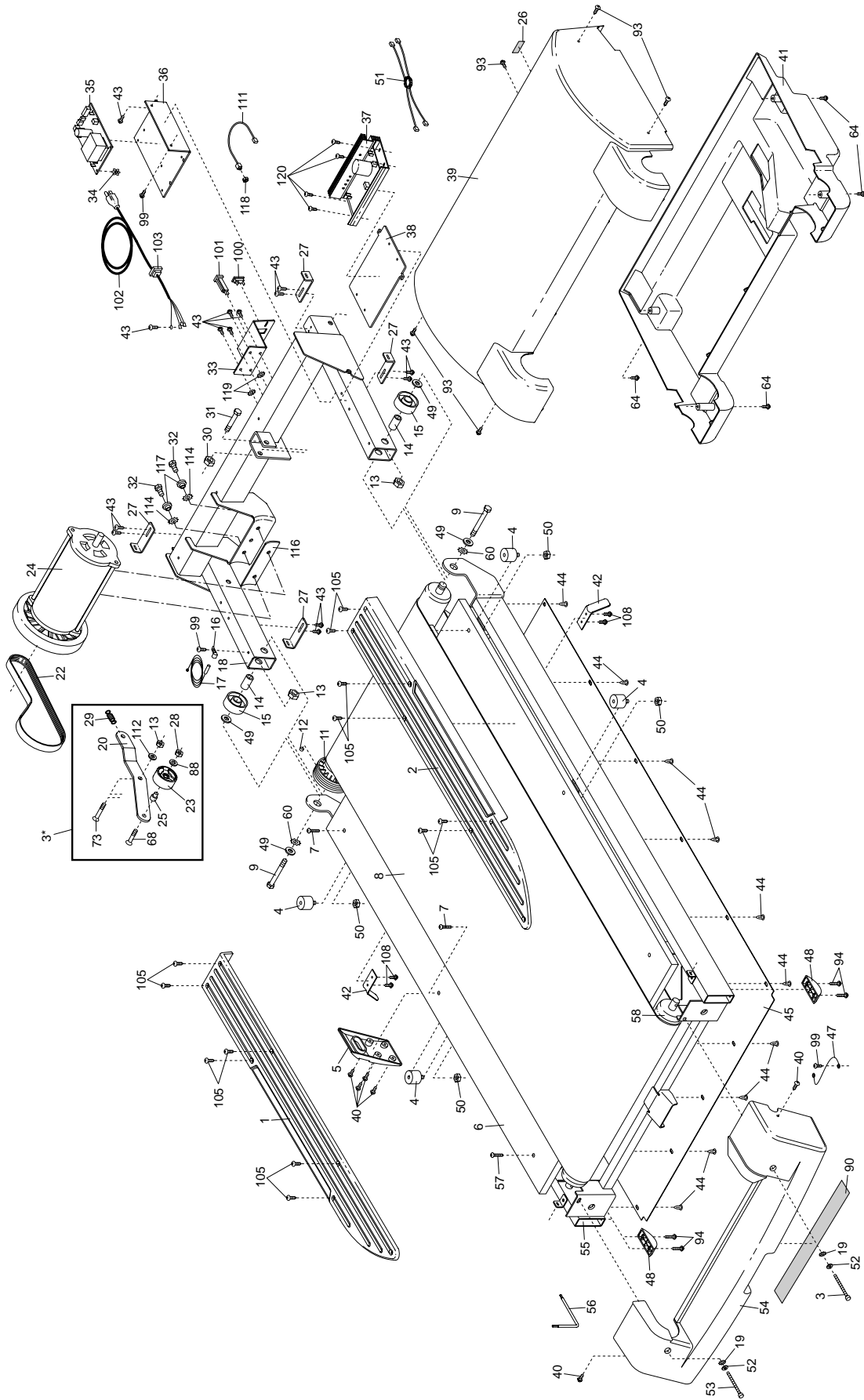

EXPLODED DRAWING—MODEL NO. RBTL14911

R0402A

