

EXPLODED DRAWING A

Model No. RBTL99013.1 R0215A

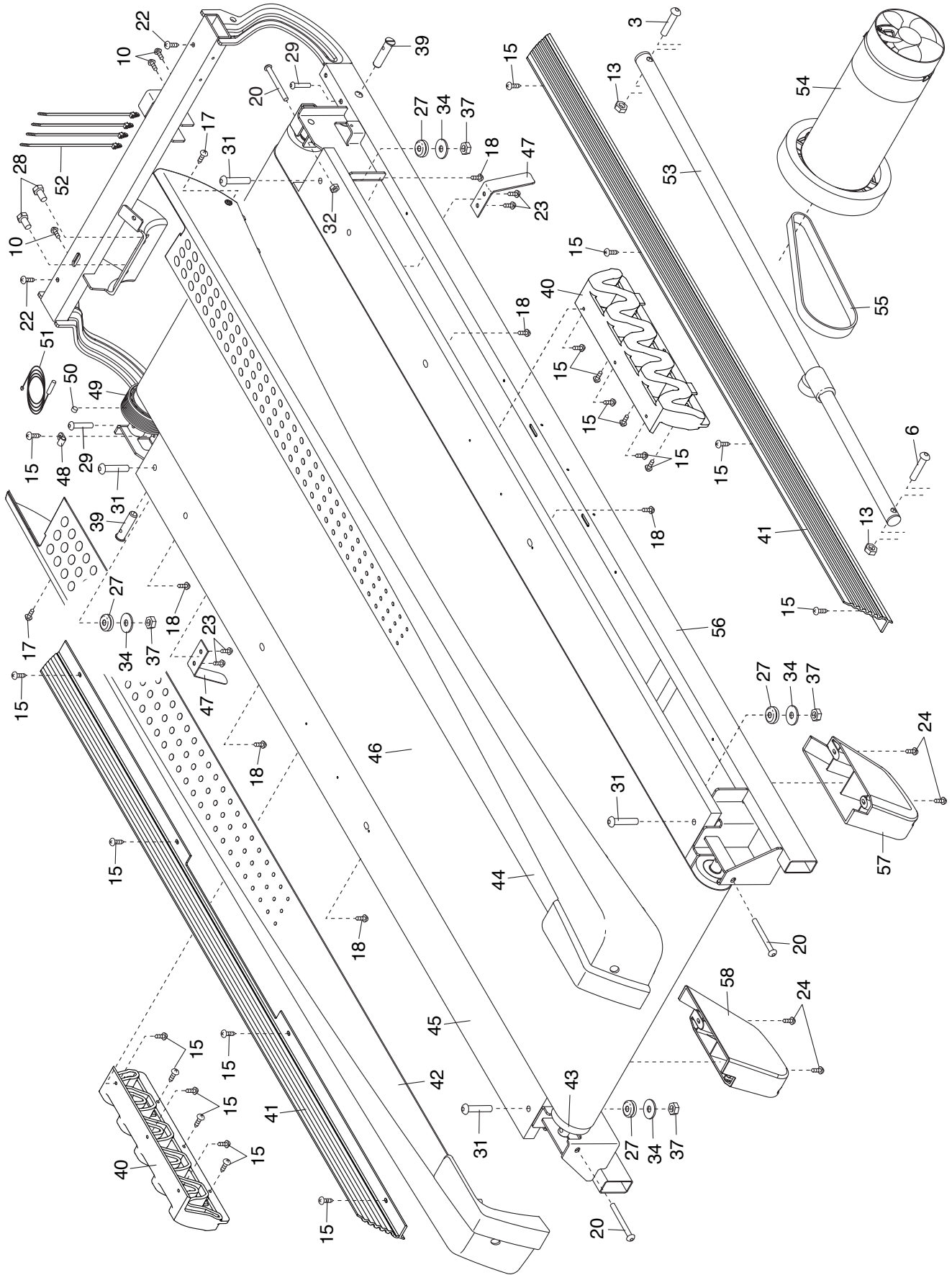

EXPLODED DRAWING B

Model No. RBTL99013.1 R0215A

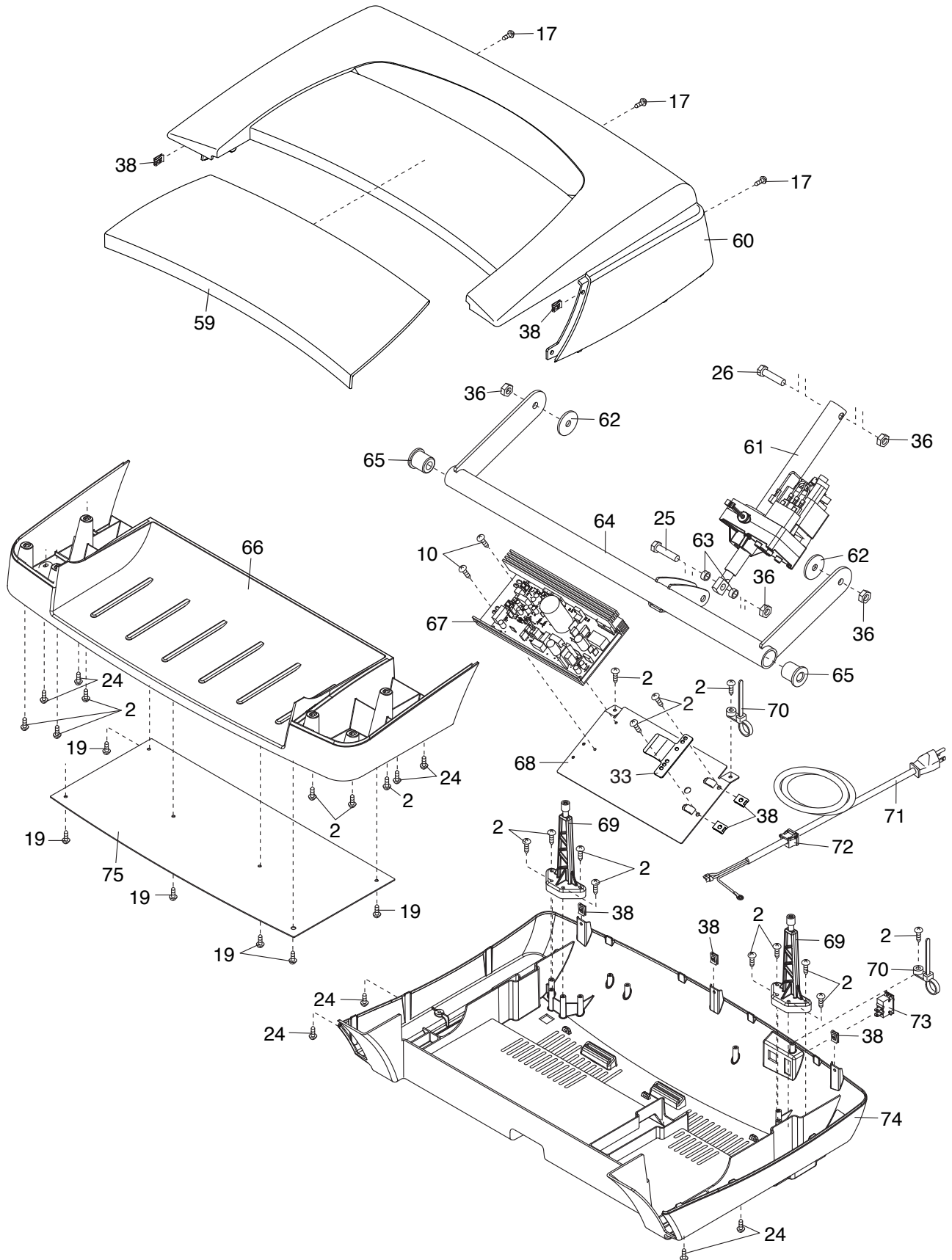

EXPLODED DRAWING C

Model No. RBTL99013.1 R0215A

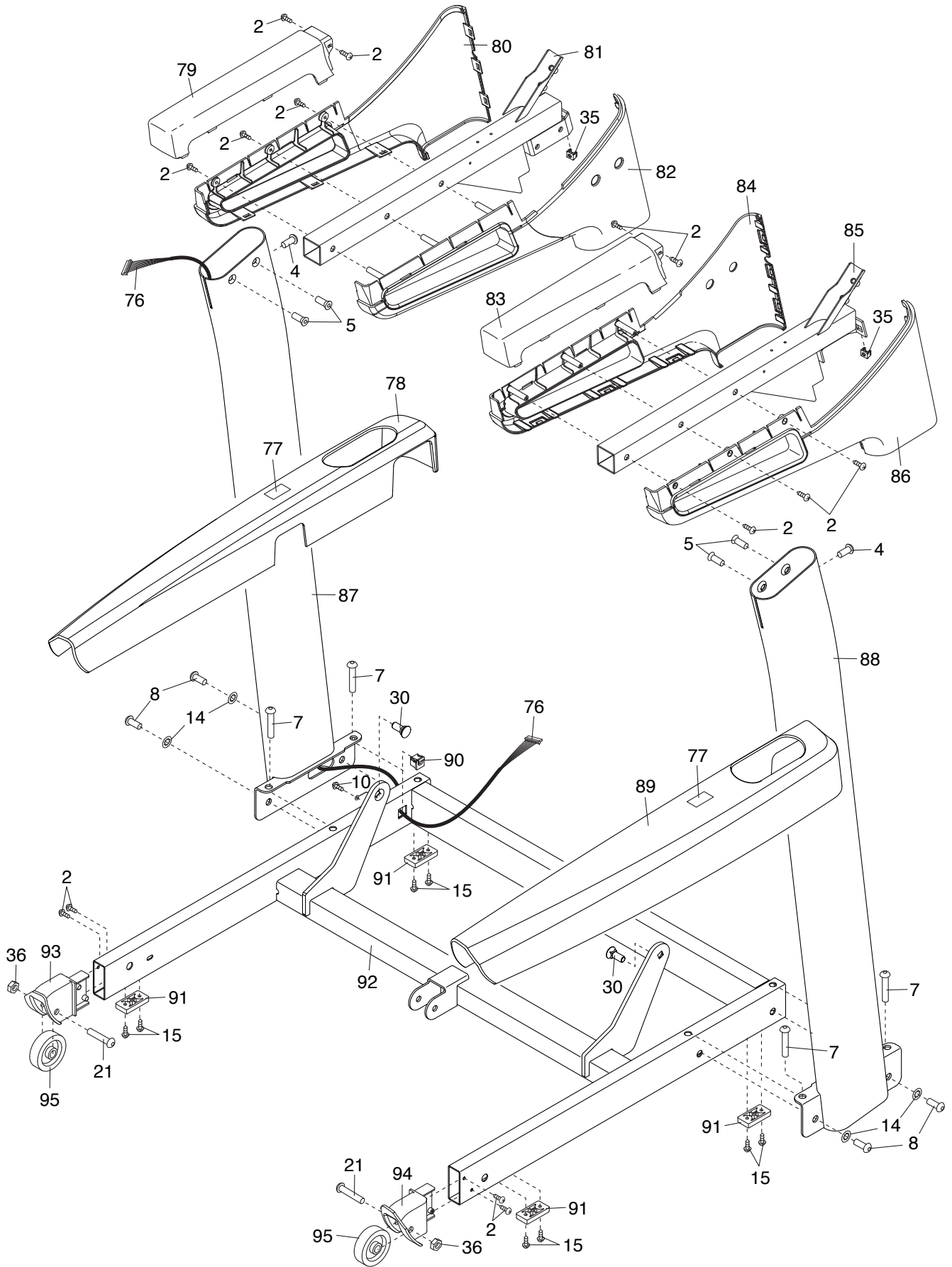

EXPLODED DRAWING D

Model No. RBTL99013.1 R0215A

