

EXPLODED DRAWING A—Model No. SFEL16009.2

R0810A

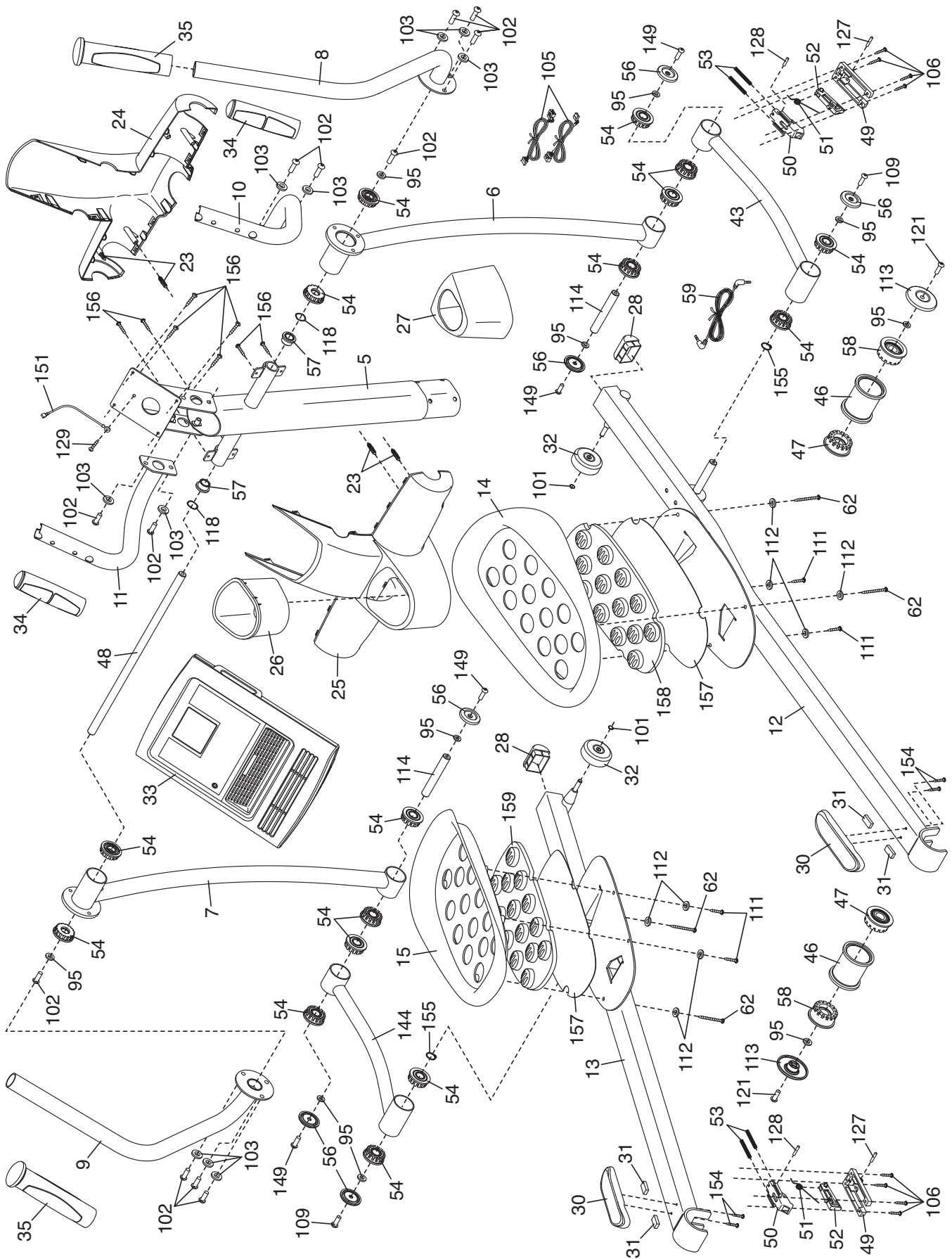

EXPLODED DRAWING B – Model No. SFEL16009.2

R0810A

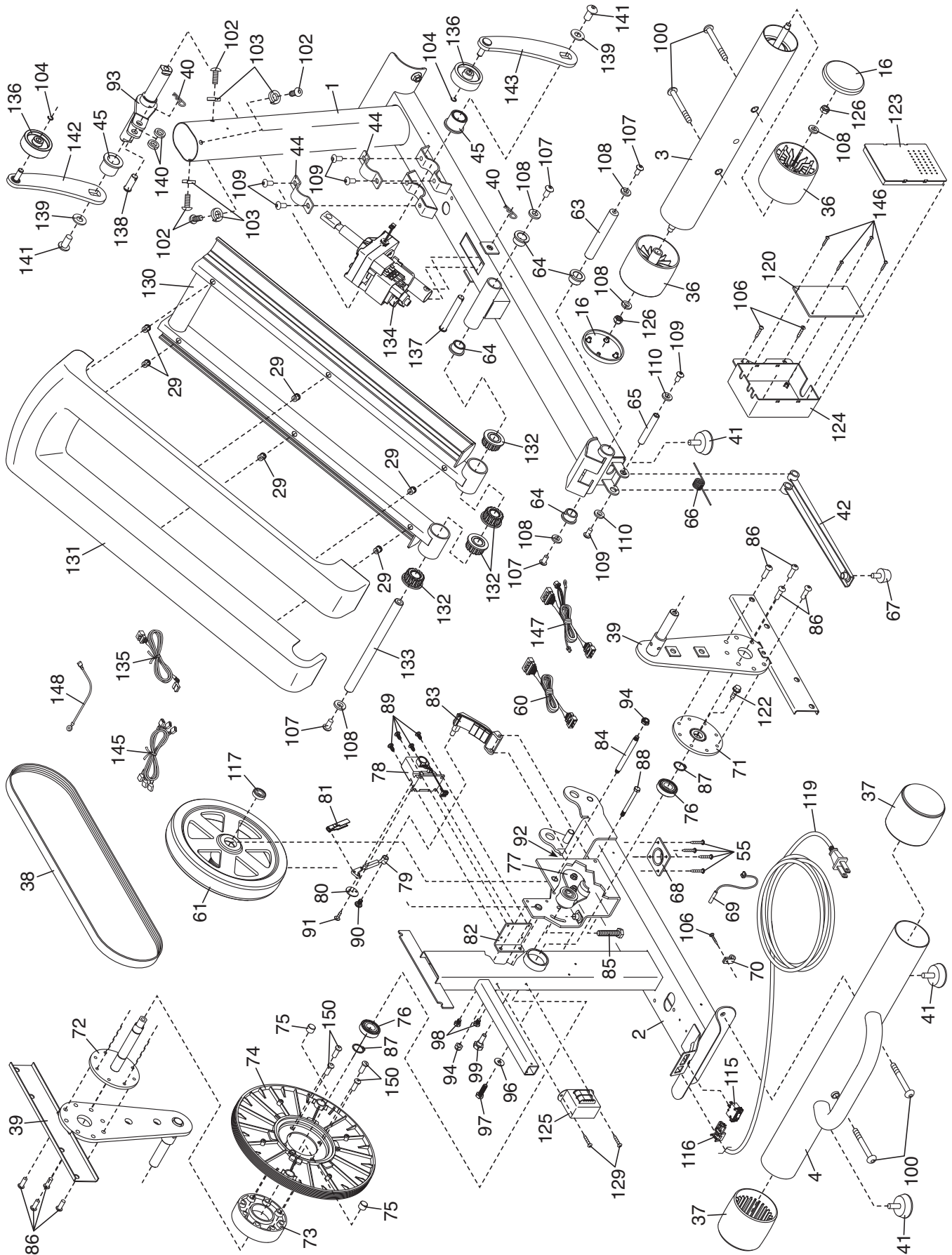

EXPLODED DRAWING C—Model No. SFEL16009.2

R0810A

