

# EXPLODED DRAWING A

Model No. SFEL16112.2 R0513A

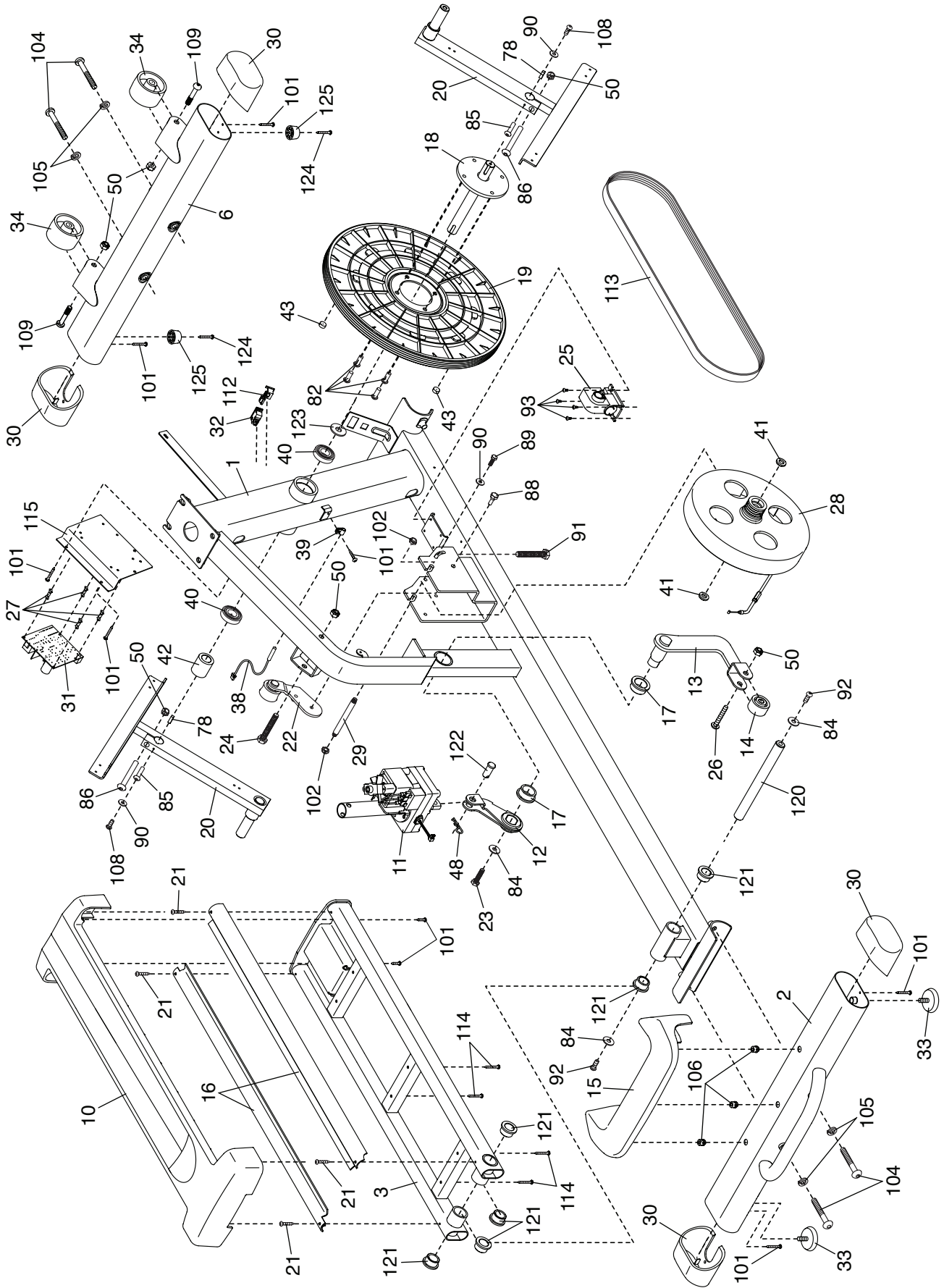

# EXPLODED DRAWING B

Model No. SFEL16112.2 R0513A

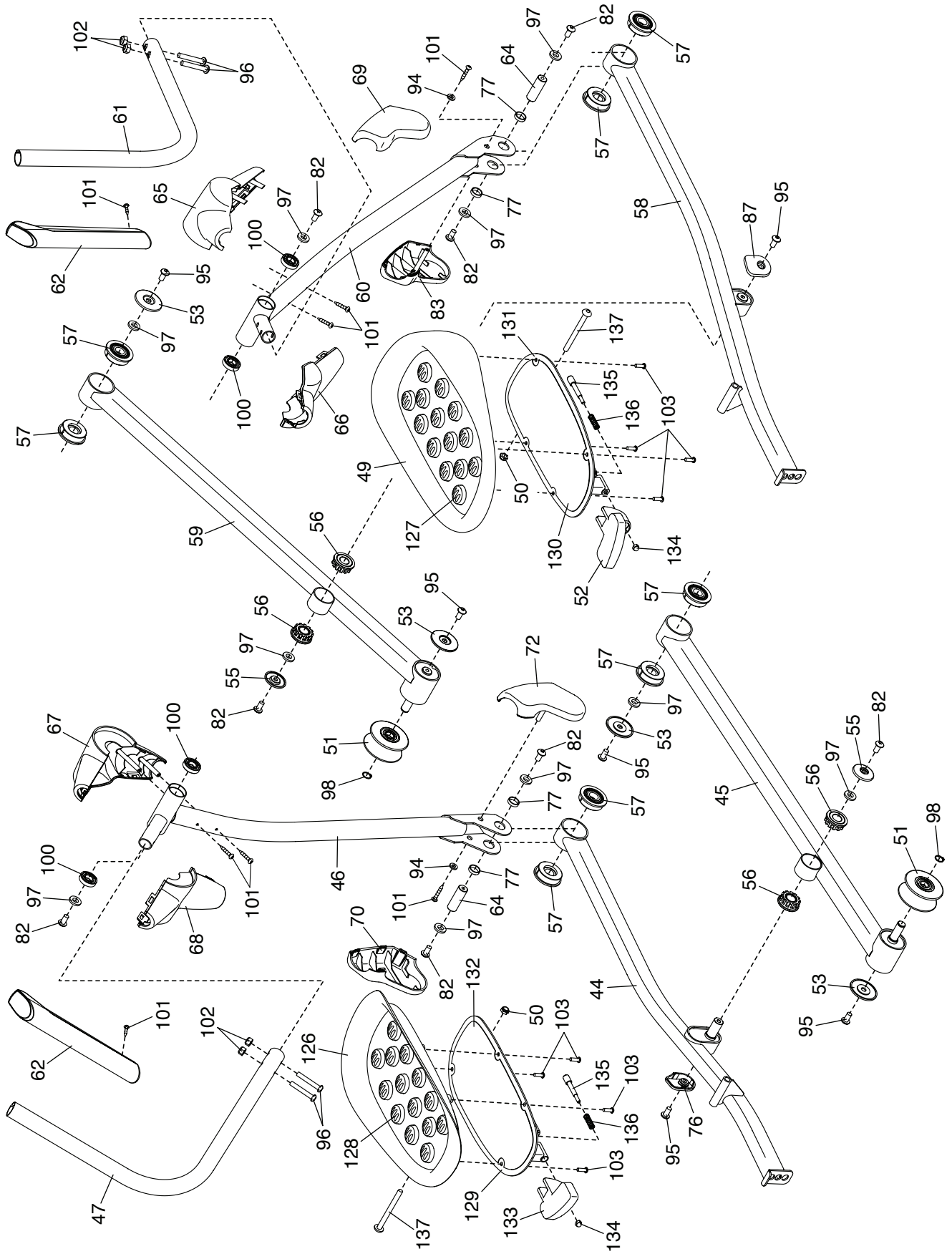

# EXPLODED DRAWING C

Model No. SFEL16112.2 R0513A

