

# EXPLODED DRAWING A

Model No. SFEL58014.0 R1114A

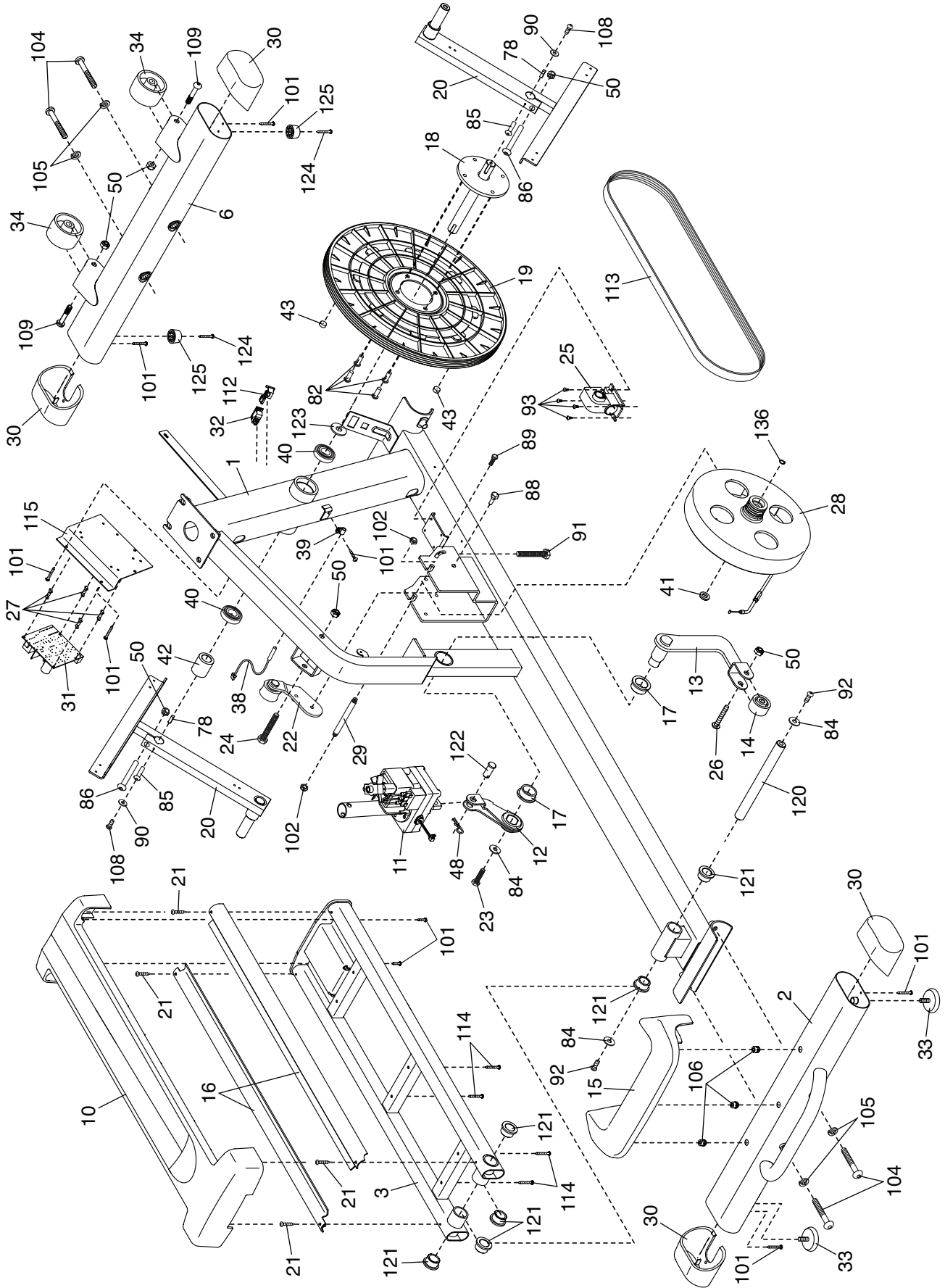

# EXPLODED DRAWING B

Model No. SFEL58014.0 R1114A

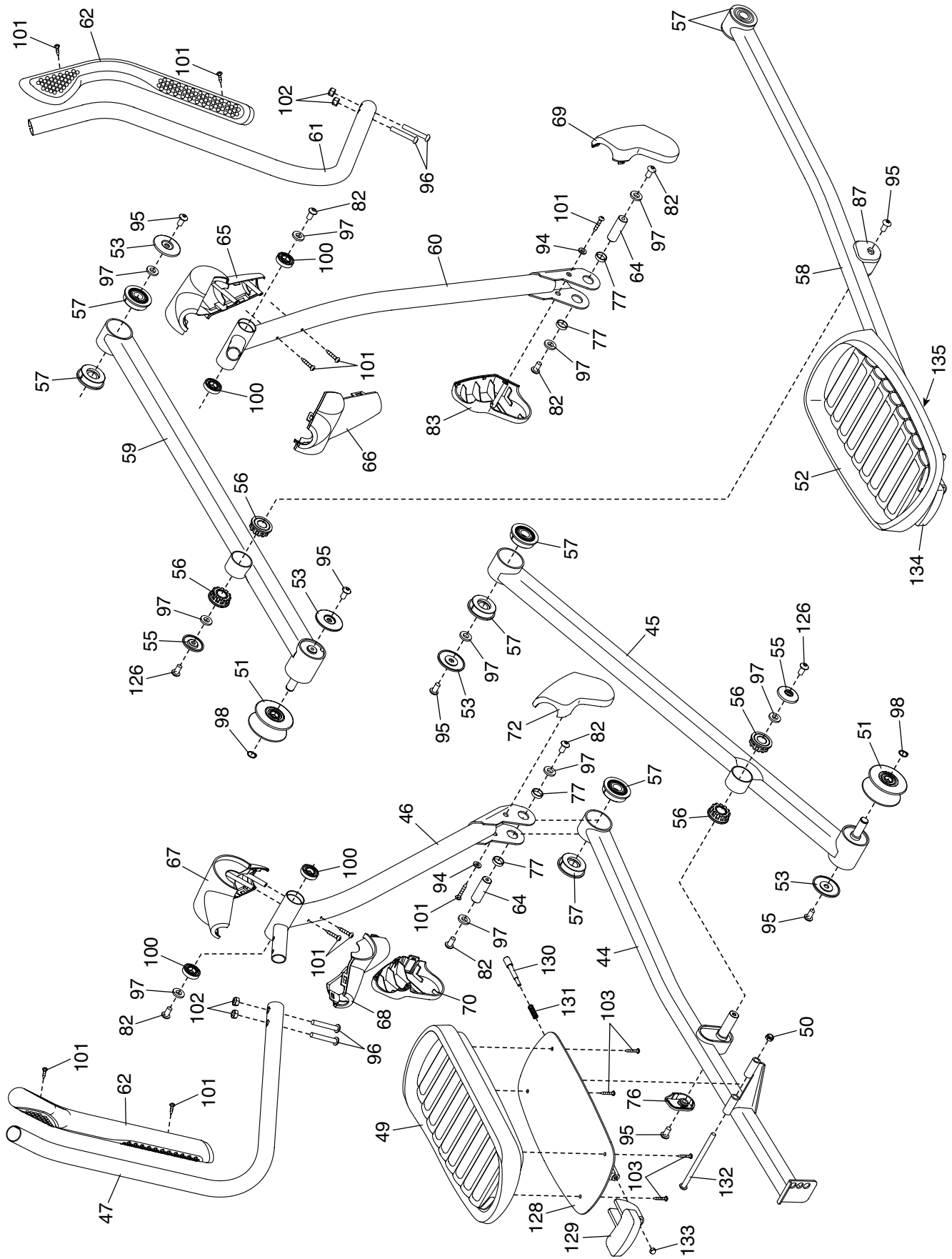

# EXPLODED DRAWING C

Model No. SFEL58014.0 R1114A

