

# EXPLODED DRAWING A

Model No. SFEL58014.2 R0717A

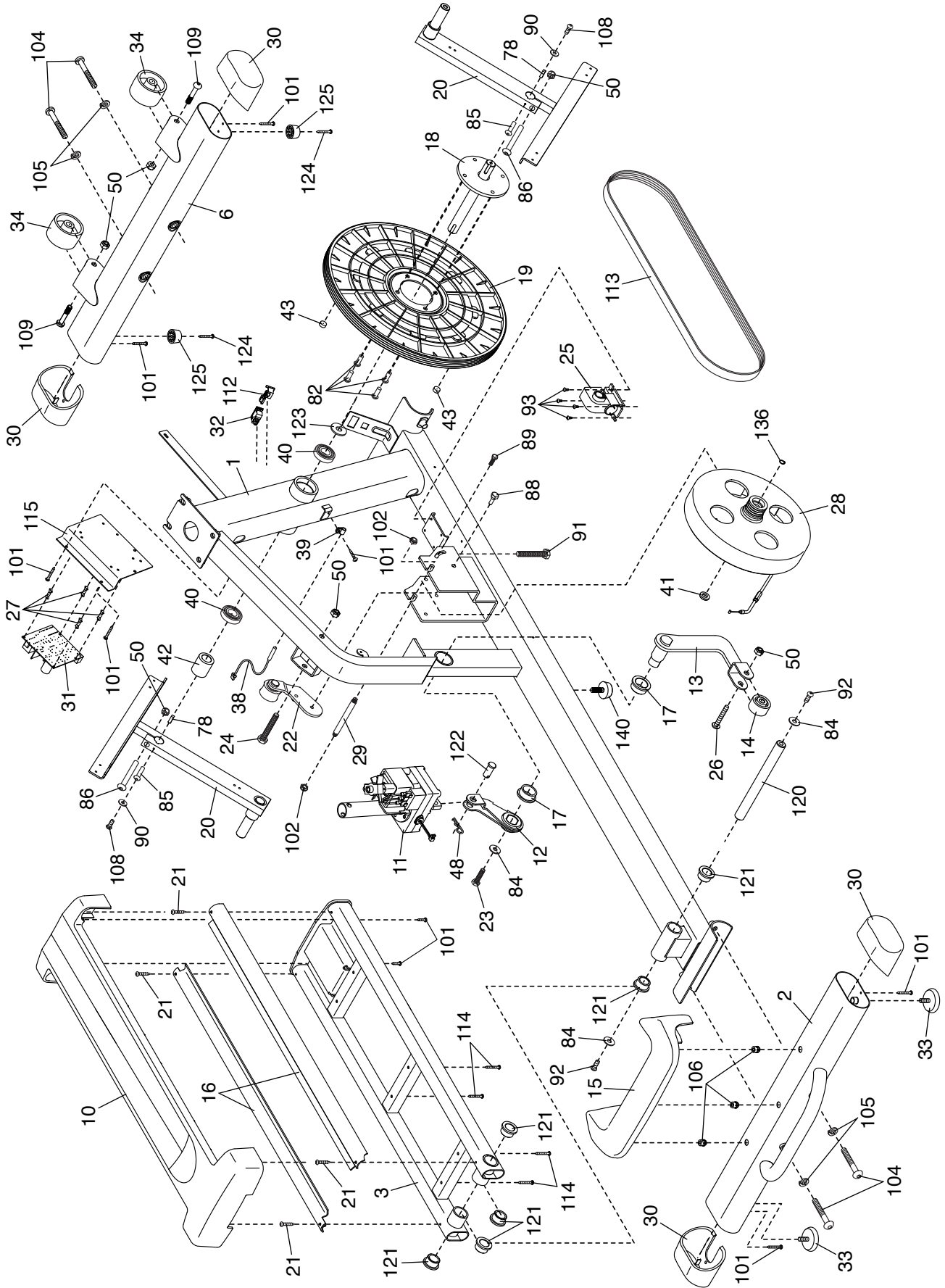

# EXPLODED DRAWING B

Model No. SFEL58014.2 R0717A

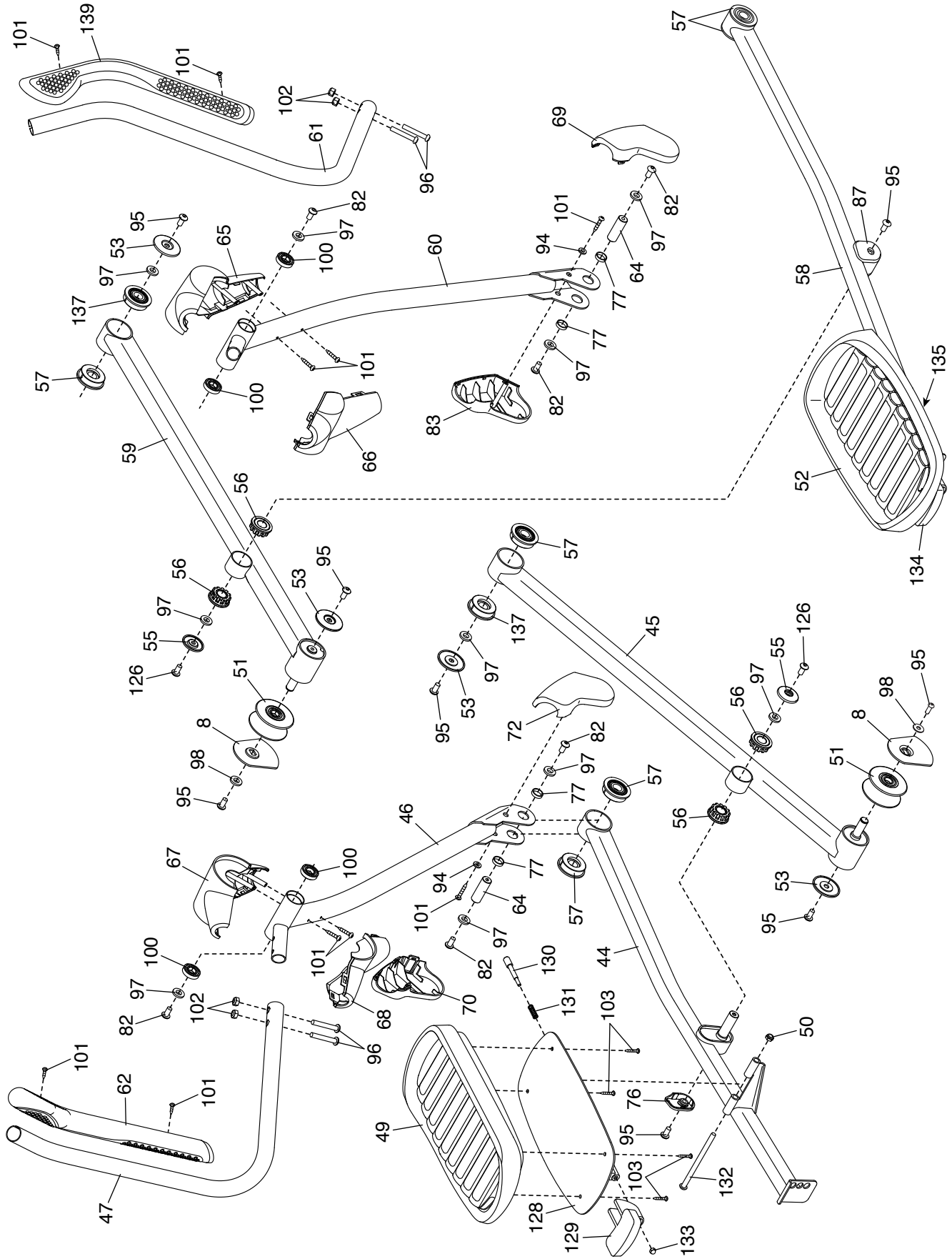

# EXPLODED DRAWING C

Model No. SFEL58014.2 R0717A

