

# EXPLODED DRAWING A

Model No. SFEL59913.0 R0714A

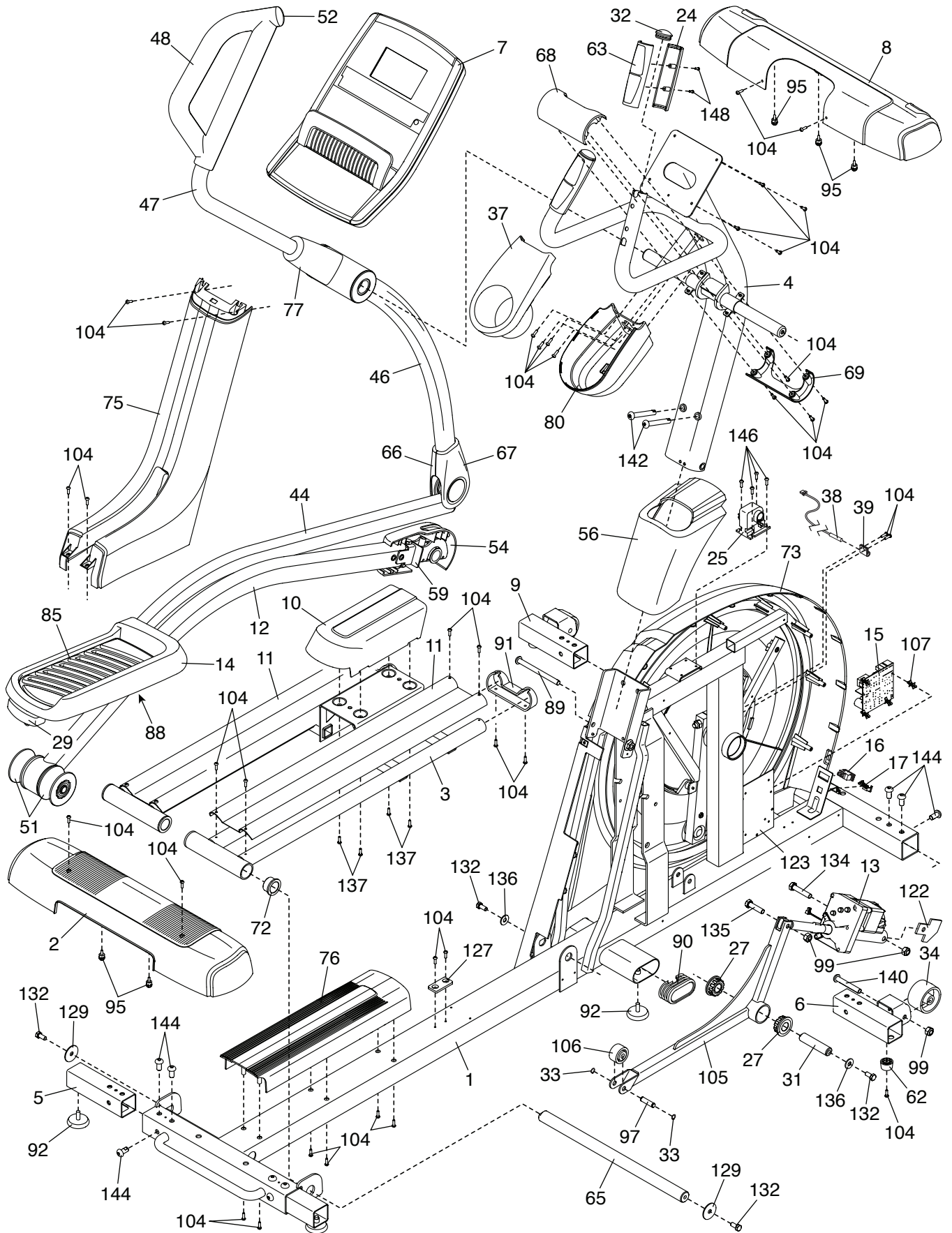

# EXPLODED DRAWING B

Model No. SFEL59913.0 R0714A

