

EXPLODED DRAWING A

Model No. SFEX13811.0 R0112A

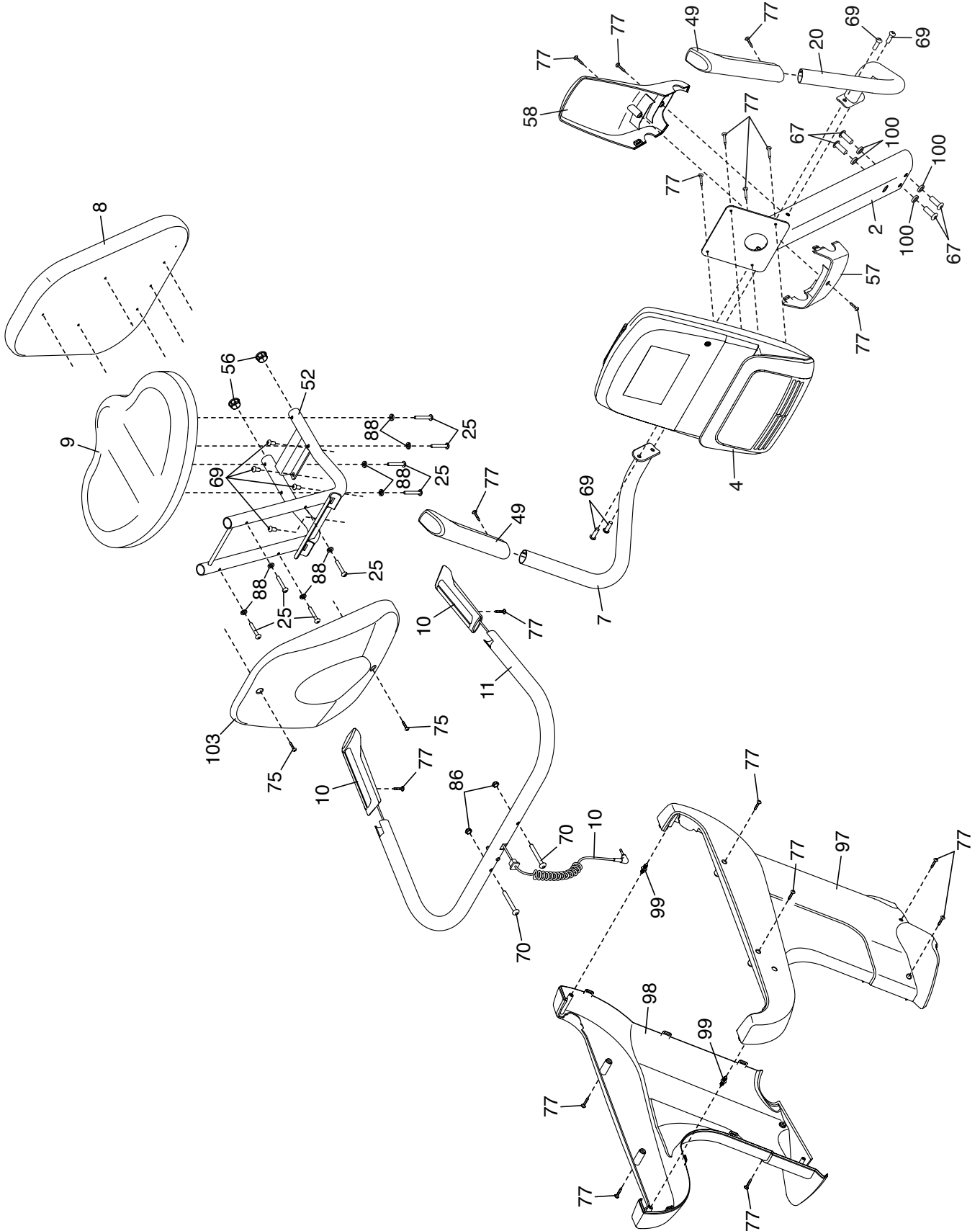

EXPLODED DRAWING B

Model No. SFEX13811.0 R0112A

