

EXPLODED DRAWING A

Model No. SFEX13811.1 R0612A

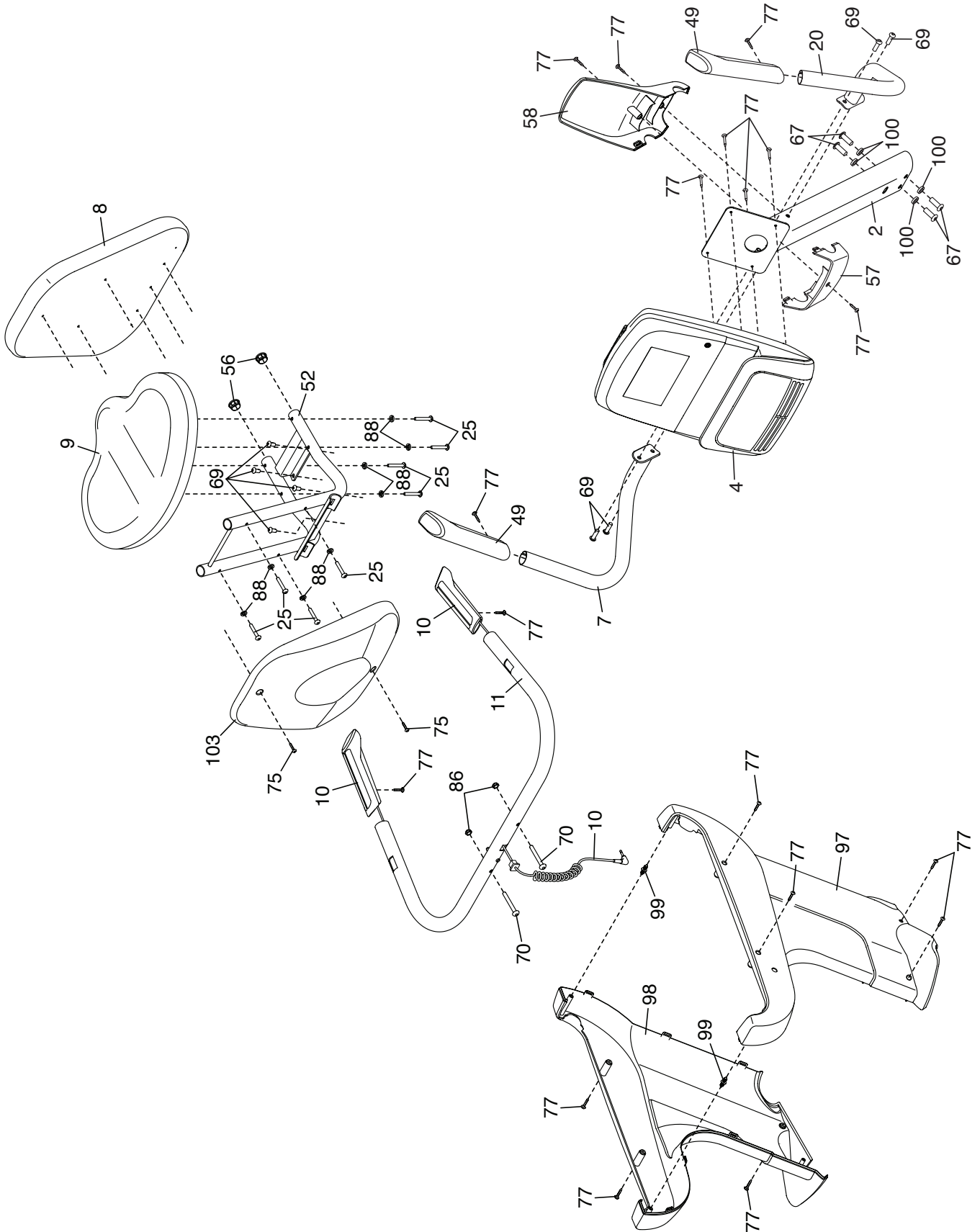

EXPLODED DRAWING B

Model No. SFEX13811.1 R0612A

