

EXPLODED DRAWING A

Model No. SFTL13513.6 R0117A

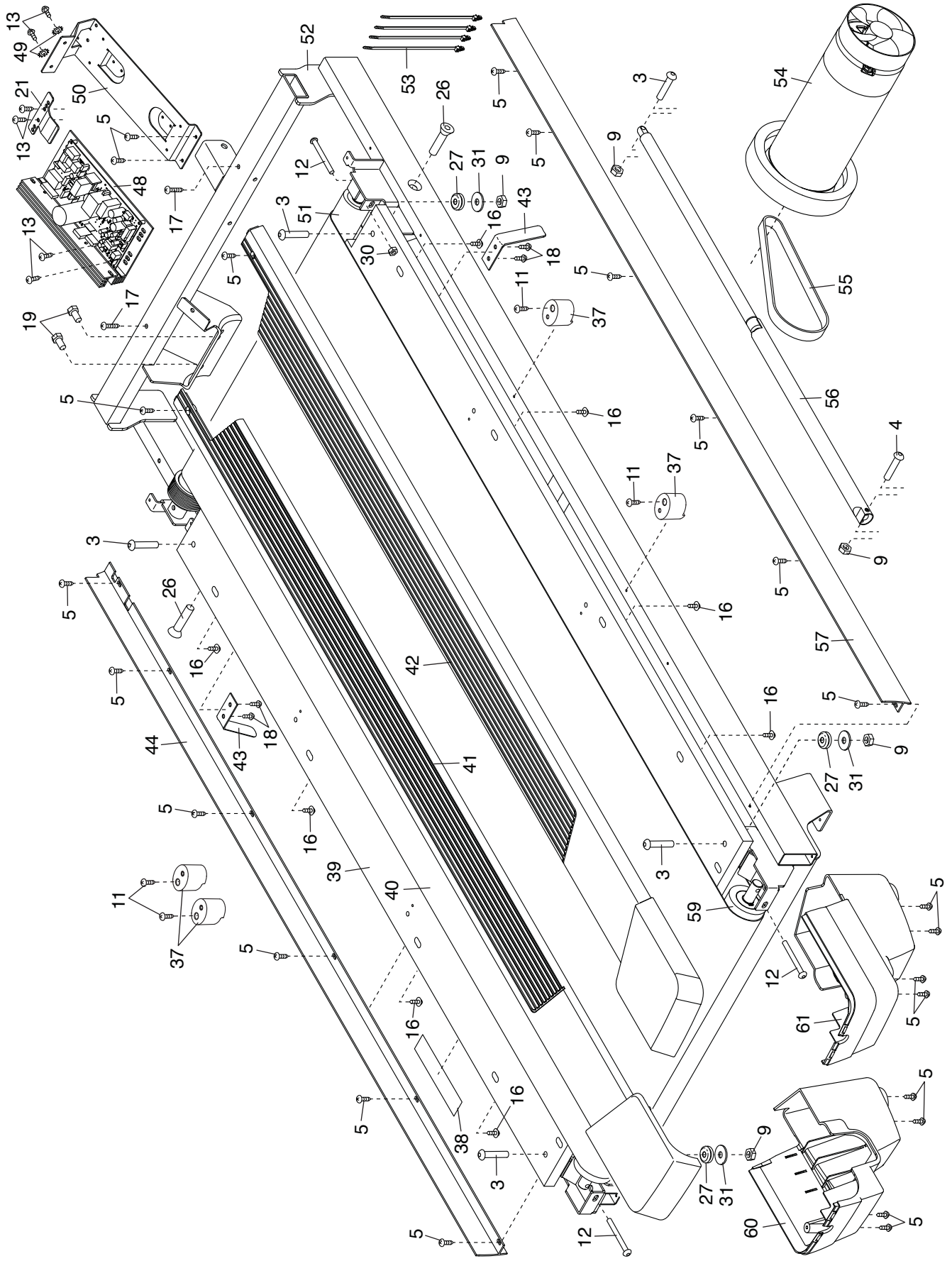

EXPLODED DRAWING B

Model No. SFTL13513.6 R0117A

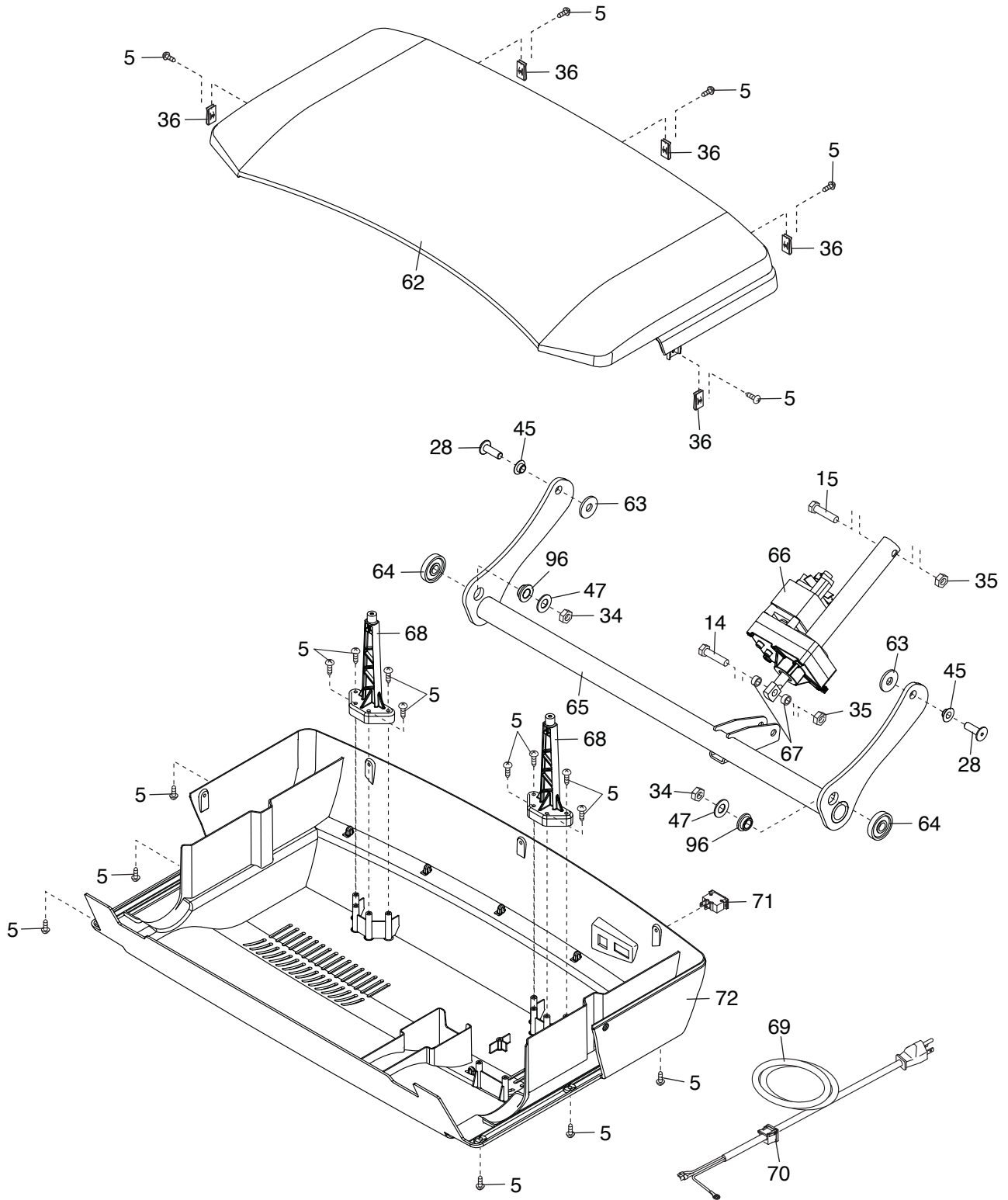

EXPLODED DRAWING C

Model No. SFTL13513.6 R0117A

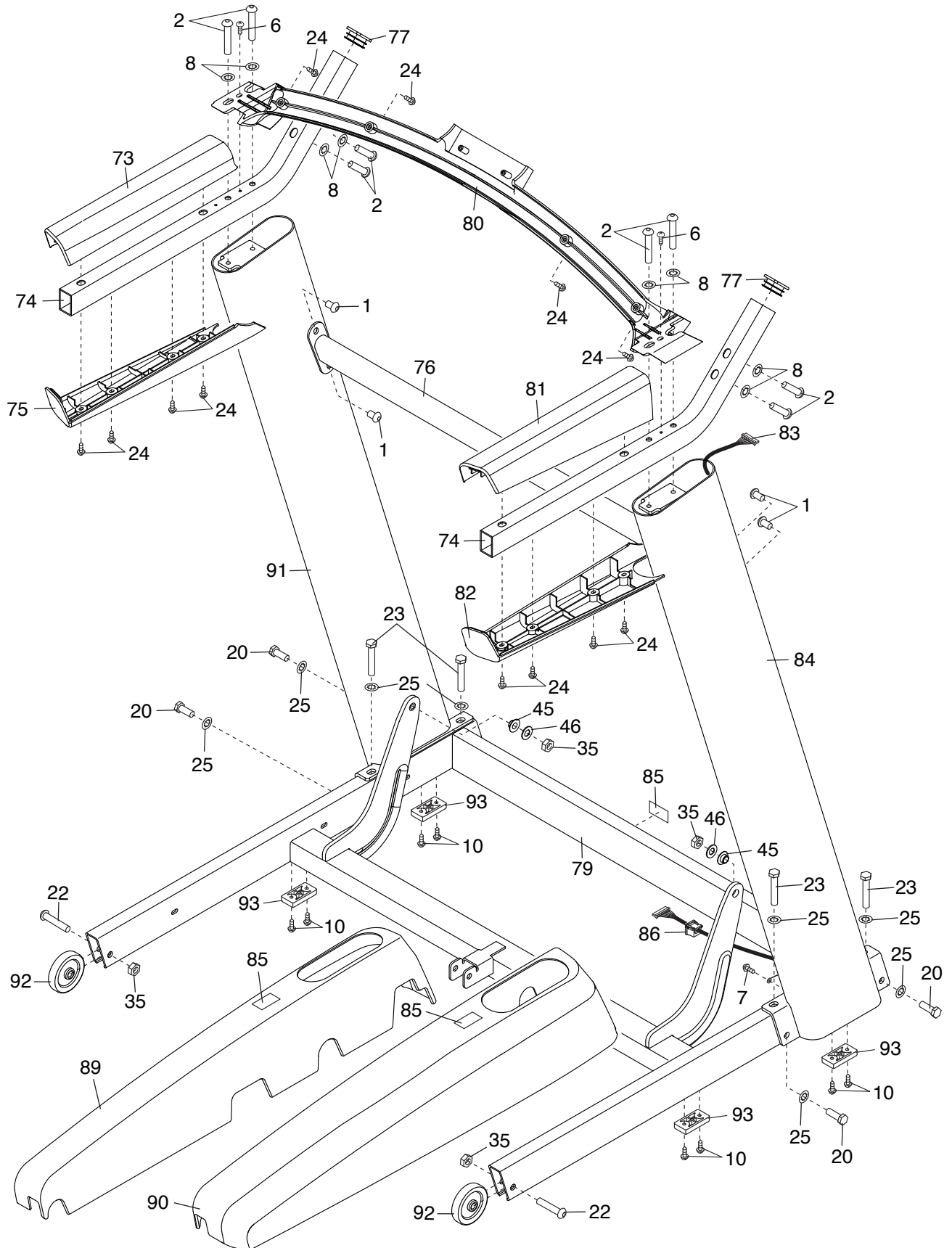

EXPLODED DRAWING D

Model No. SFTL13513.6 R0117A

