

# EXPLODED DRAWING A

Model No. SFTL15512.1 R0813A

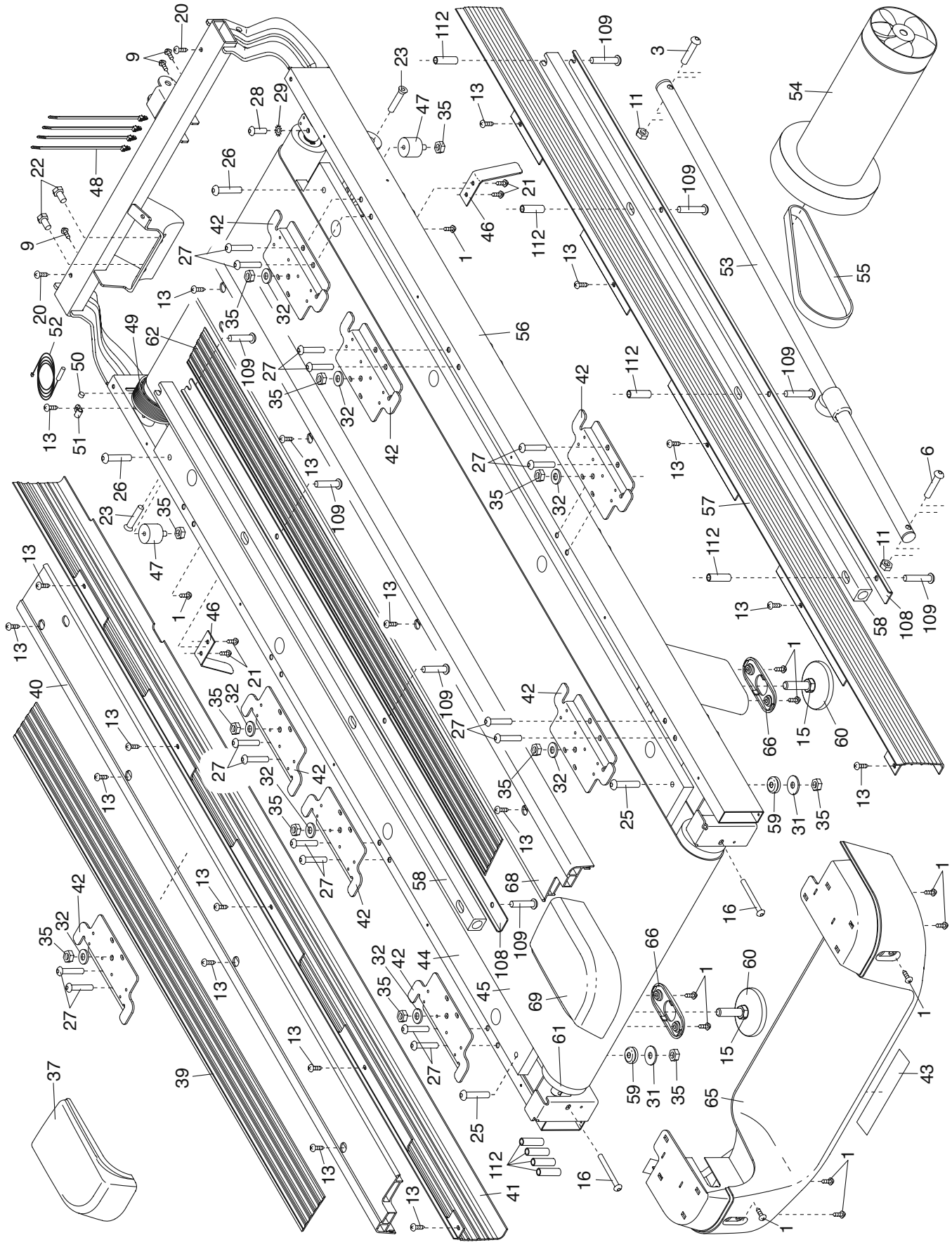

# EXPLODED DRAWING B

Model No. SFTL15512.1 R0813A

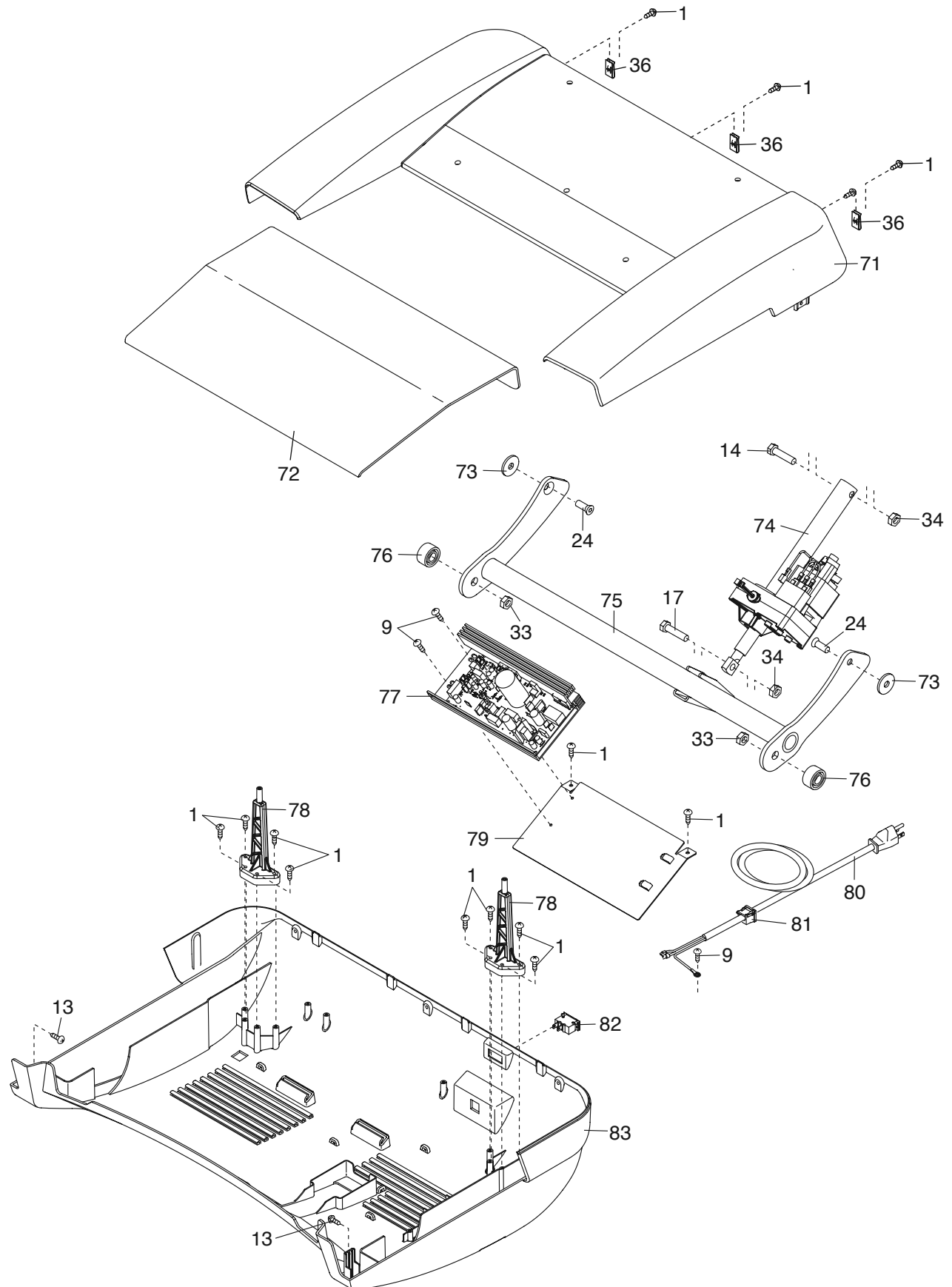

# EXPLODED DRAWING C

Model No. SFTL15512.1 R0813A

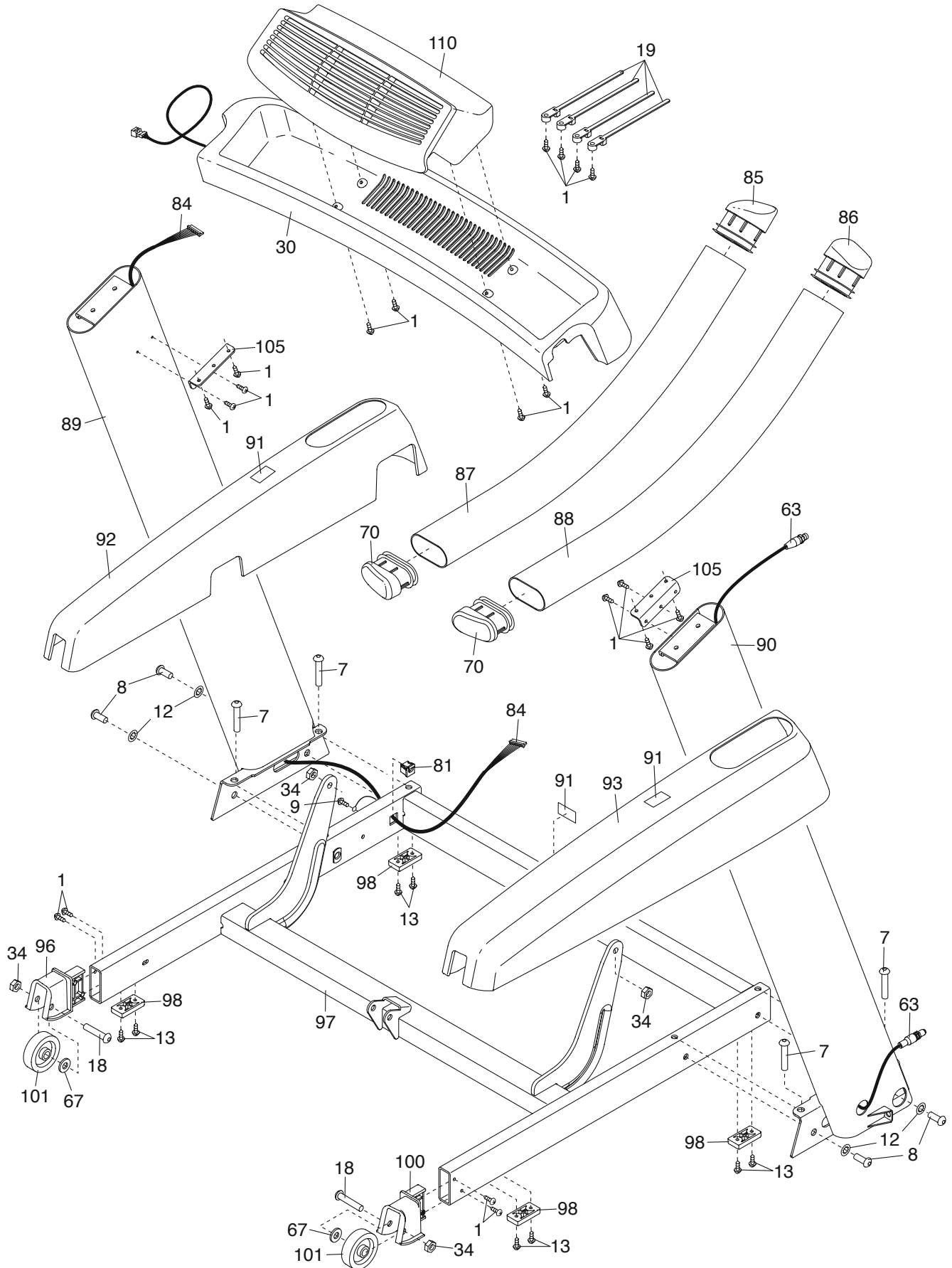

# EXPLODED DRAWING D

Model No. SFTL15512.1 R0813A

