

EXPLODED DRAWING A

Model No. SFTL15513.0 R0214A

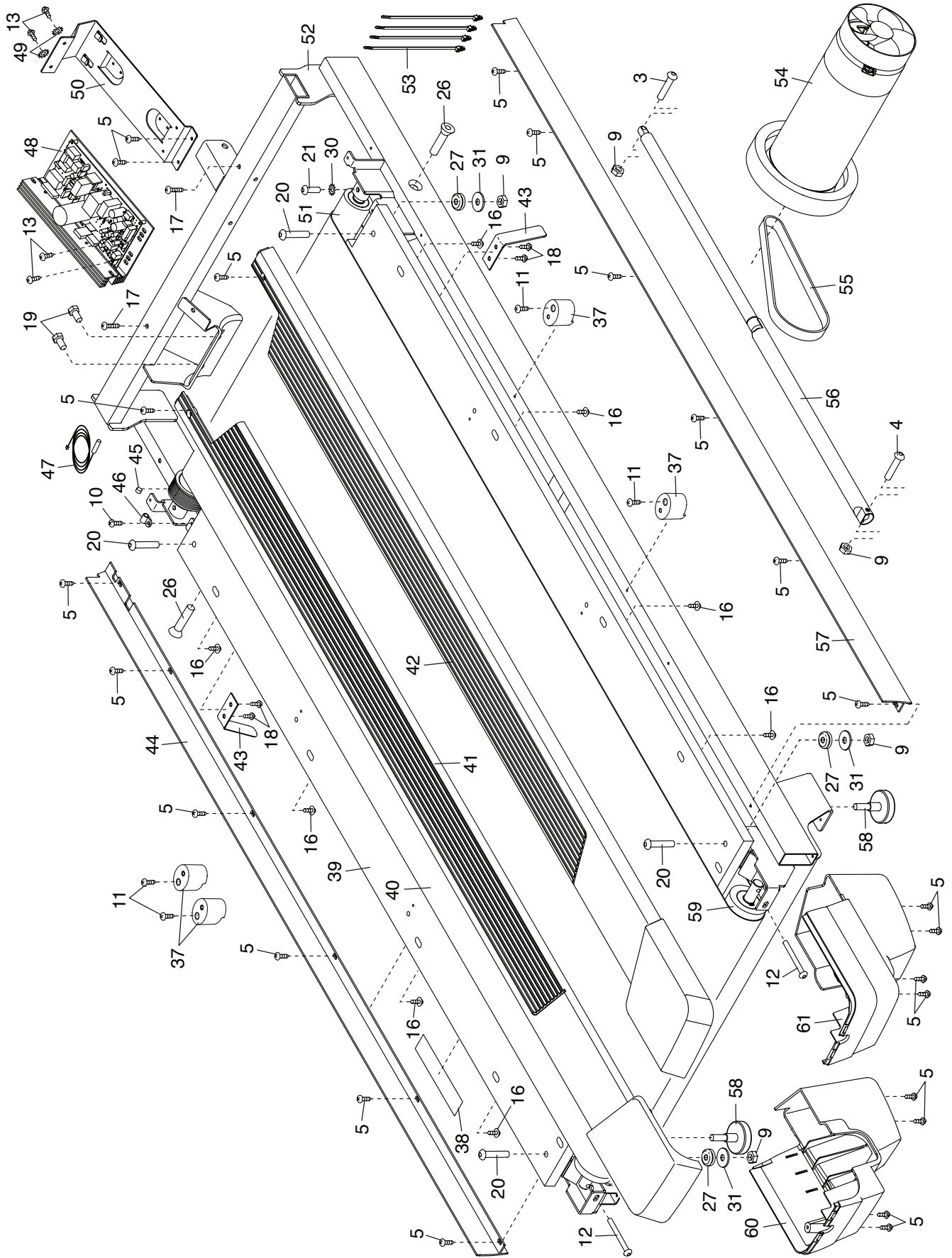

EXPLODED DRAWING B

Model No. SFTL15513.0 R0214A

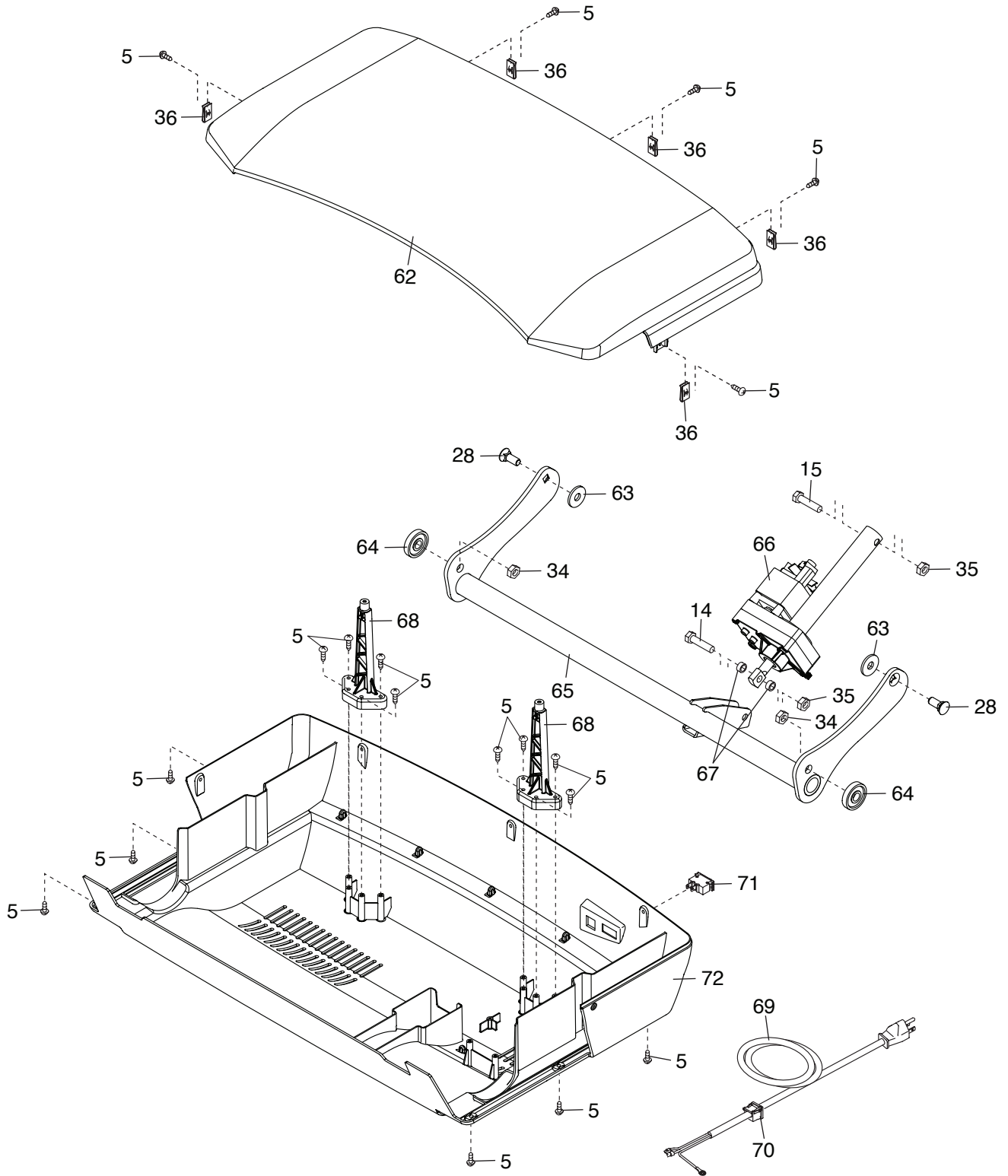

EXPLODED DRAWING C

Model No. SFTL15513.0 R0214A

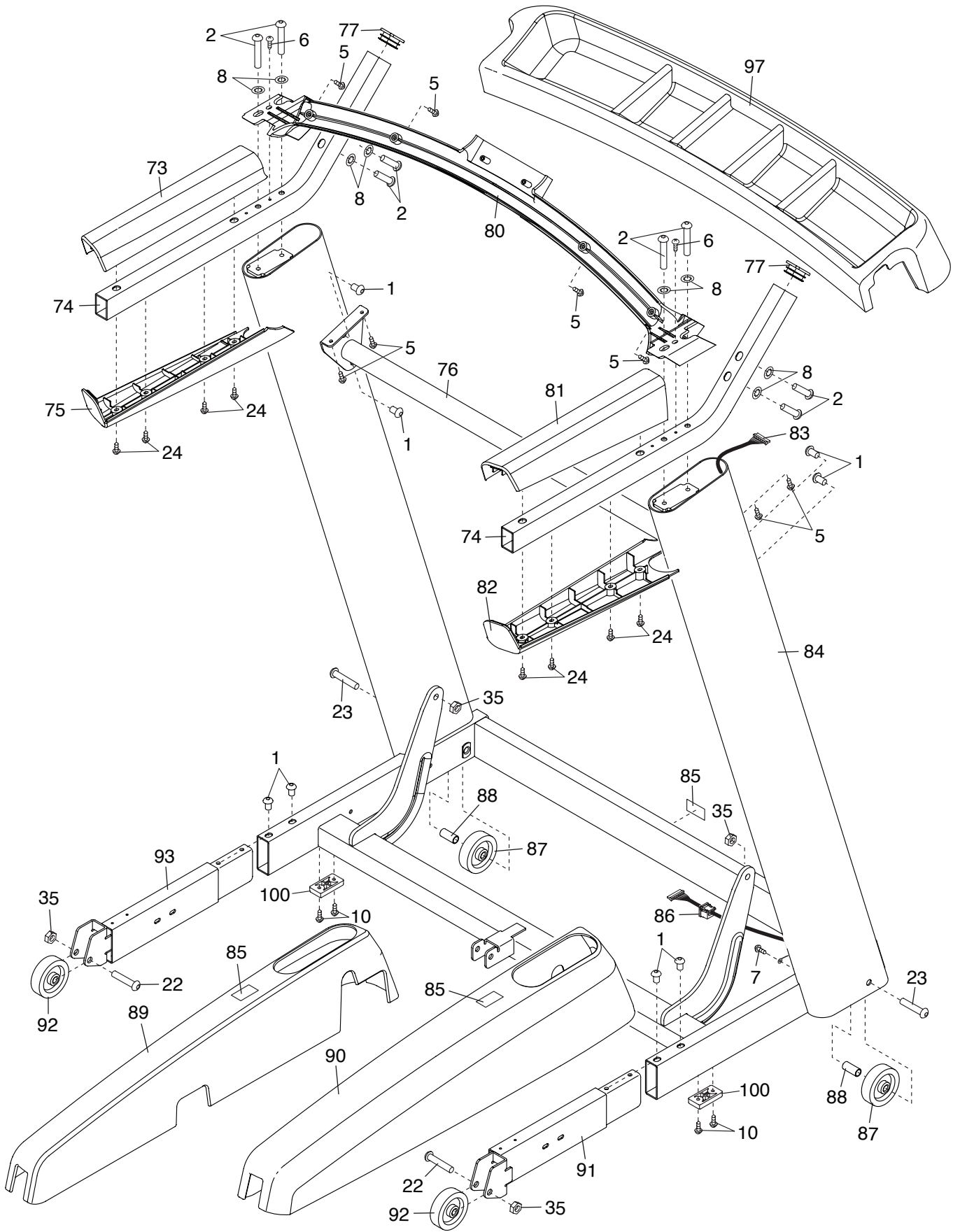

EXPLODED DRAWING D

Model No. SFTL15513.0 R0214A

