

EXPLODED DRAWING A

Model No. SFTL15513.3 R0915A

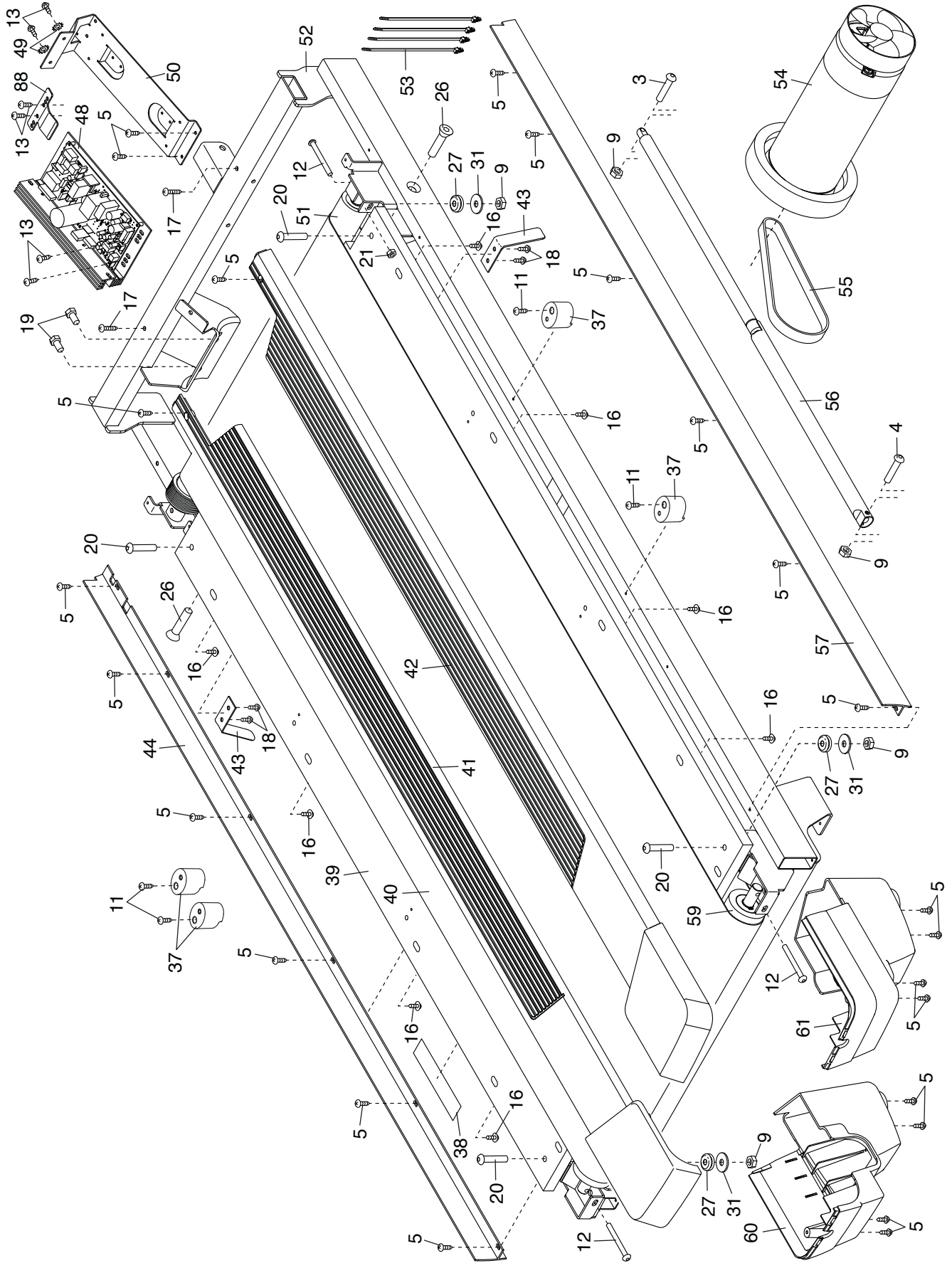

EXPLODED DRAWING B

Model No. SFTL15513.3 R0915A

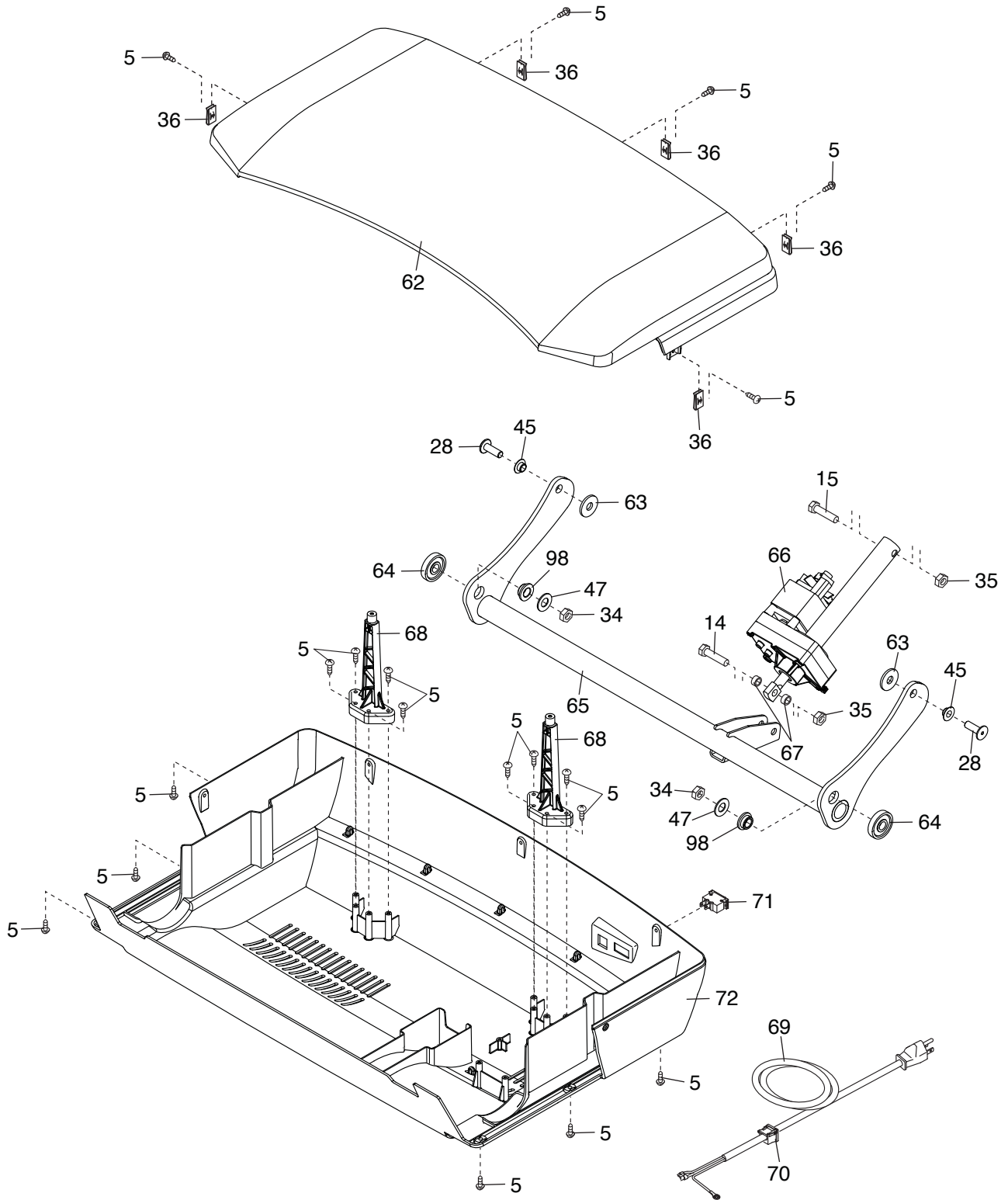

EXPLODED DRAWING C

Model No. SFTL15513.3 R0915A

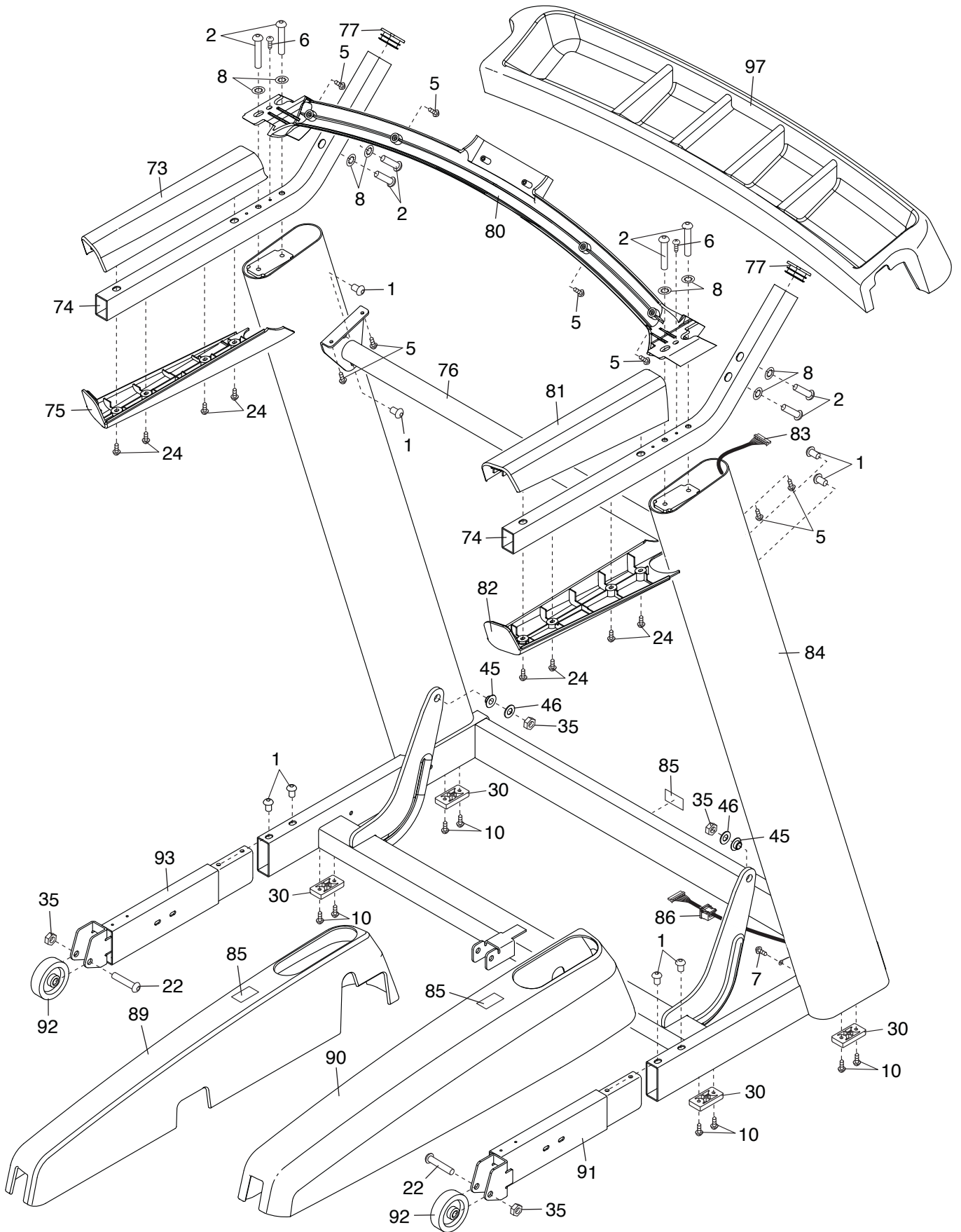

EXPLODED DRAWING D

Model No. SFTL15513.3 R0915A

