

EXPLODED DRAWING A

Model No. SFTL15513.4 R1015A

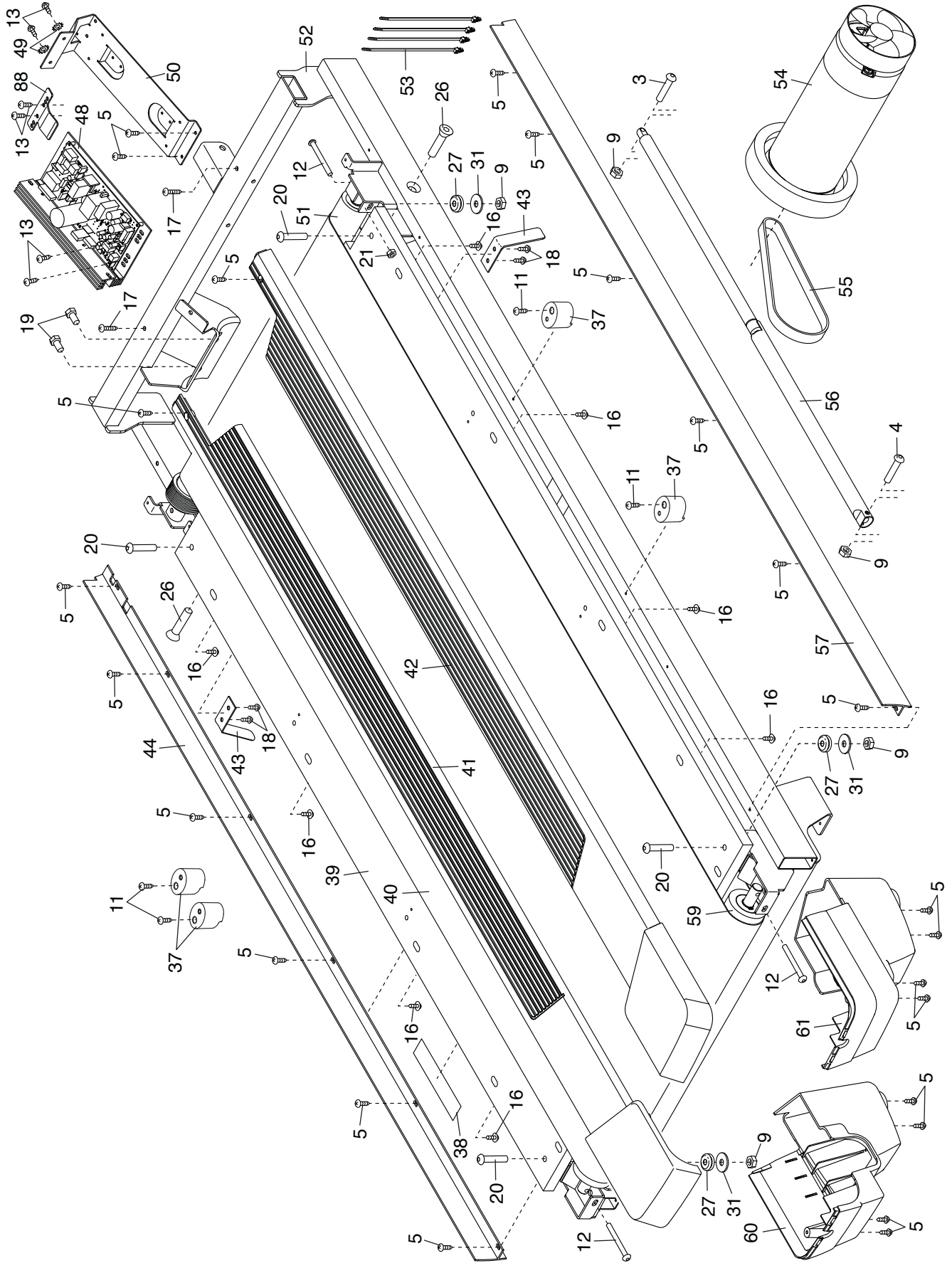

EXPLODED DRAWING B

Model No. SFTL15513.4 R1015A

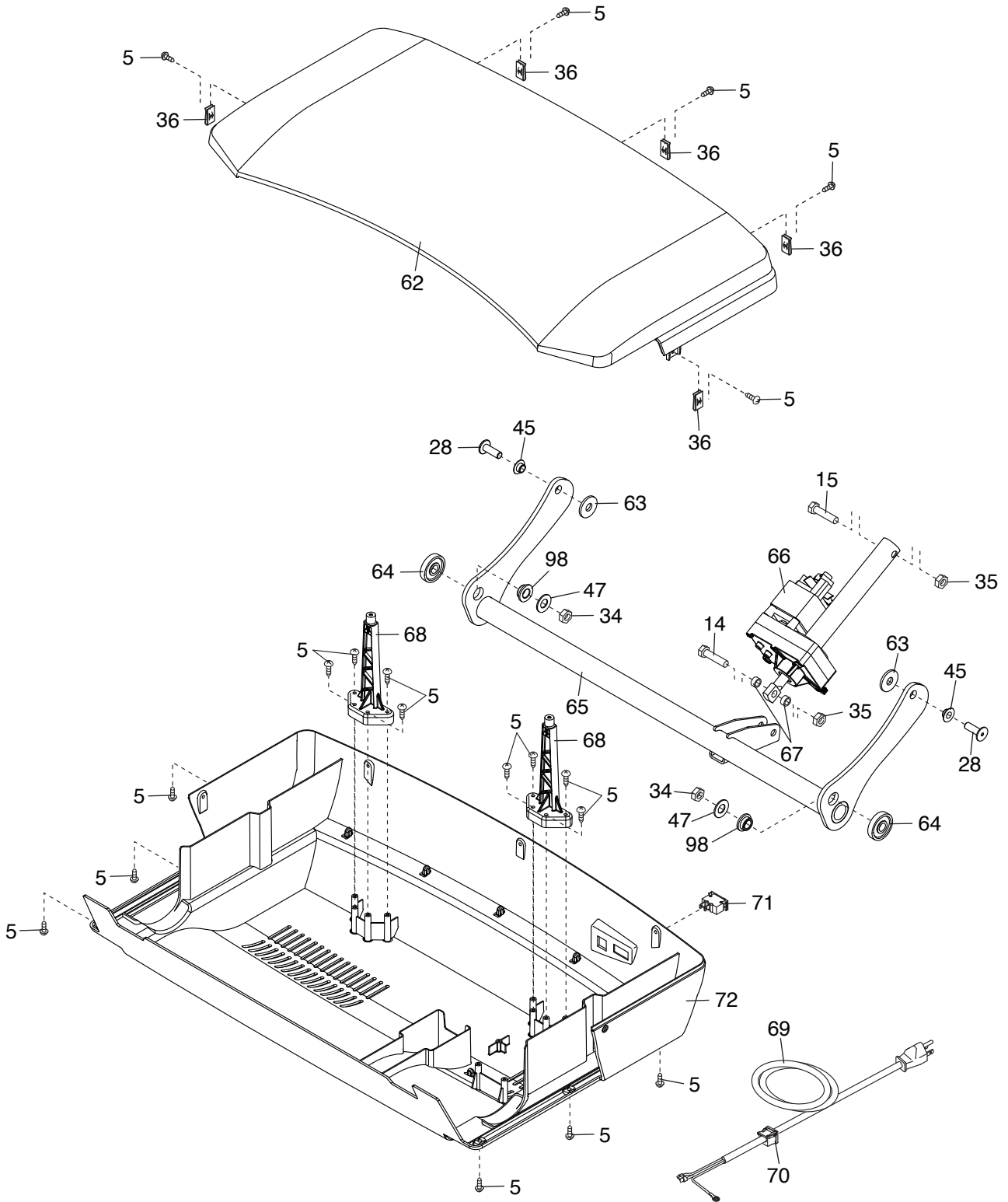

EXPLODED DRAWING C

Model No. SFTL15513.4 R1015A

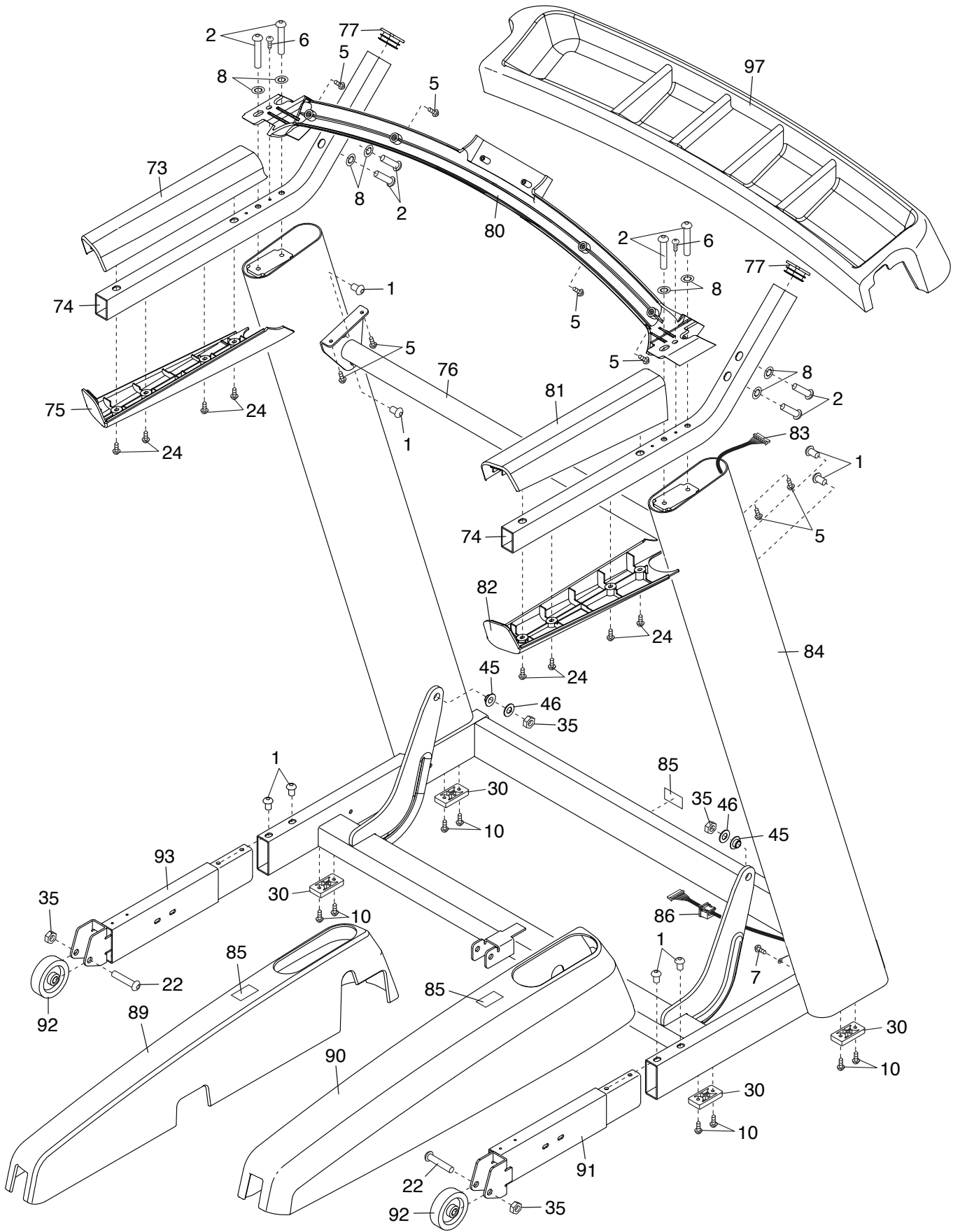

EXPLODED DRAWING D

Model No. SFTL15513.4 R1015A

