

EXPLODED DRAWING A—Model No. SFTL15609.0

R0509A

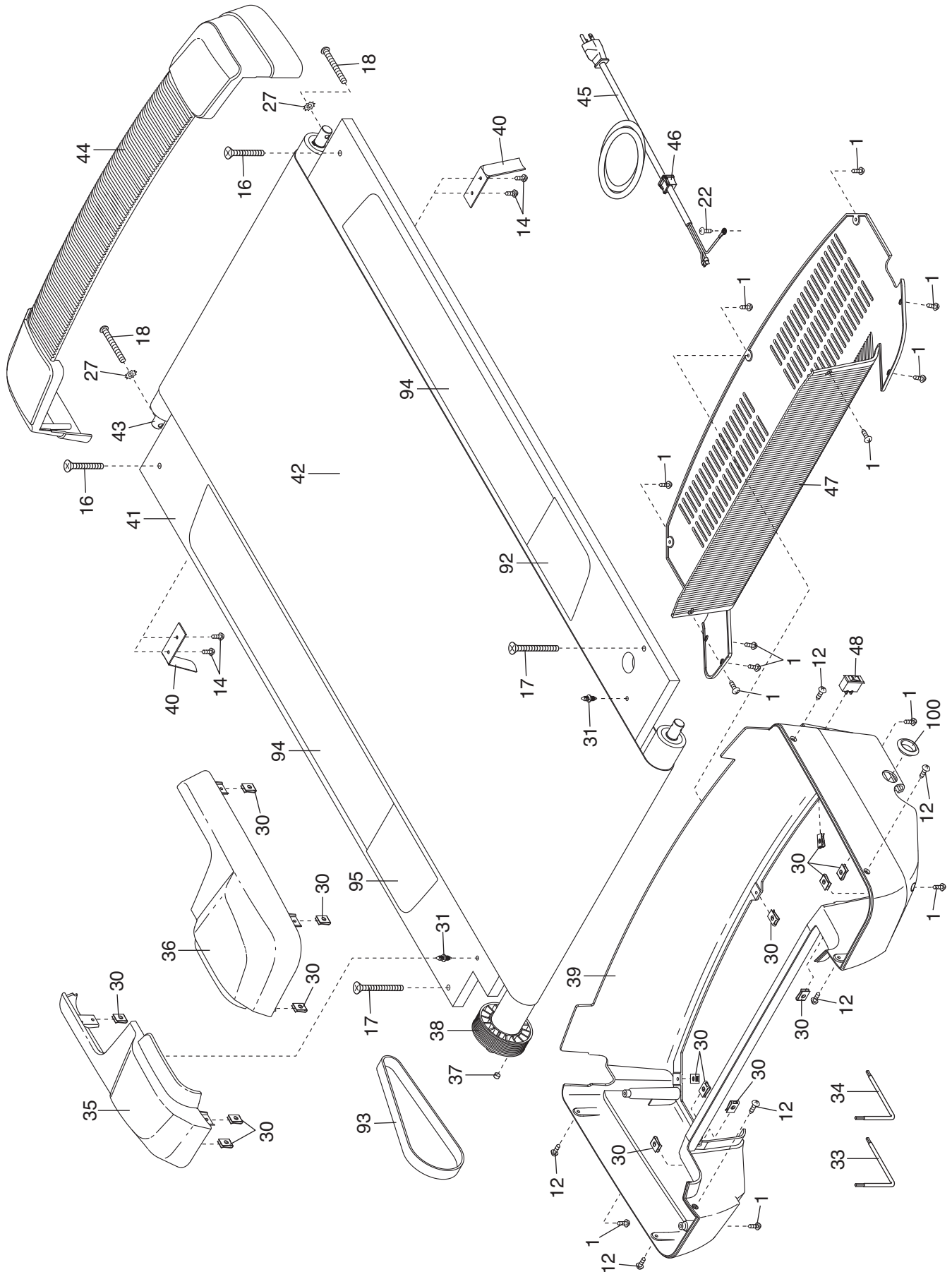

EXPLODED DRAWING B—Model No. SFTL15609.0

R0509A

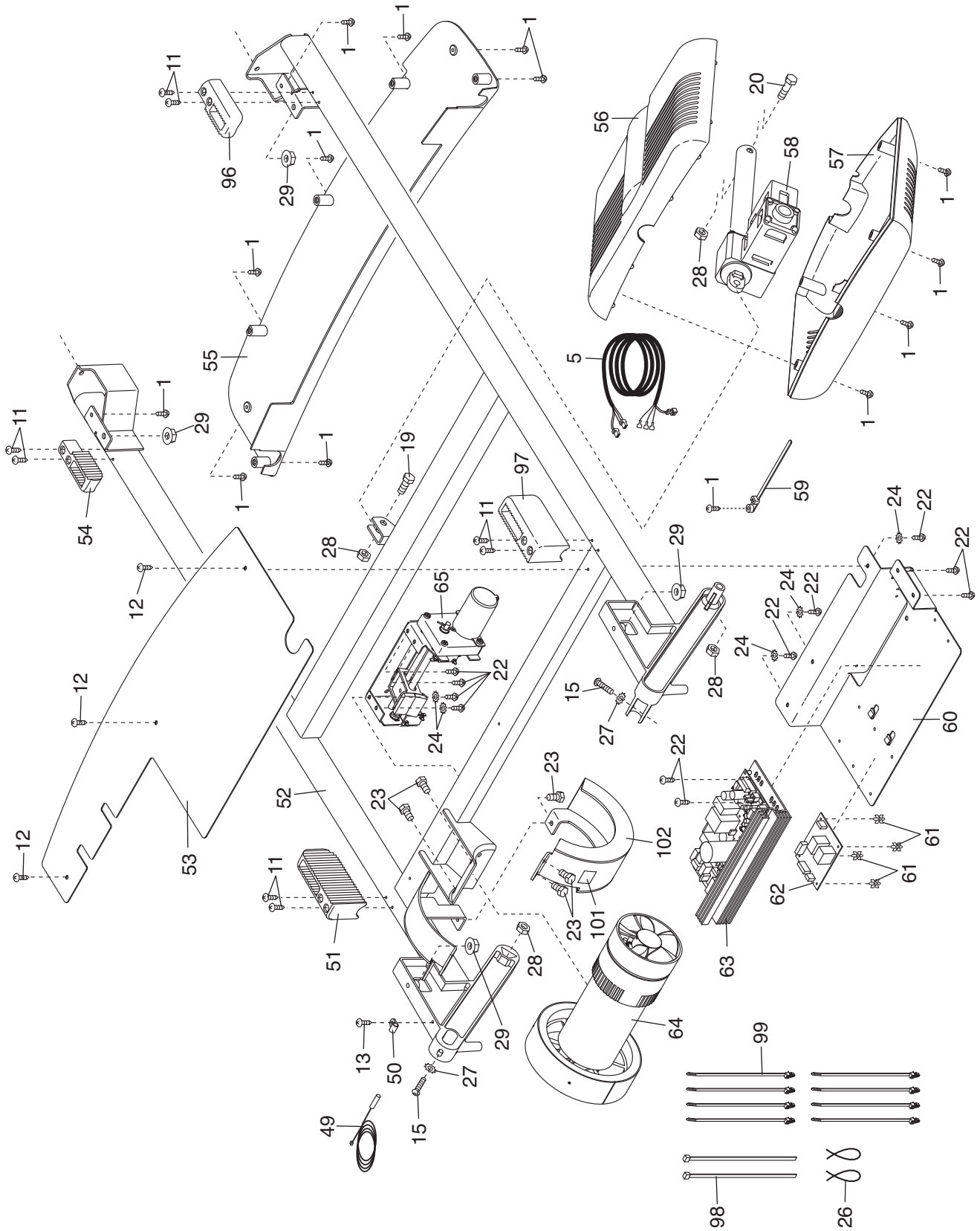

EXPLODED DRAWING C—Model No. SFTL15609.0

R0509A

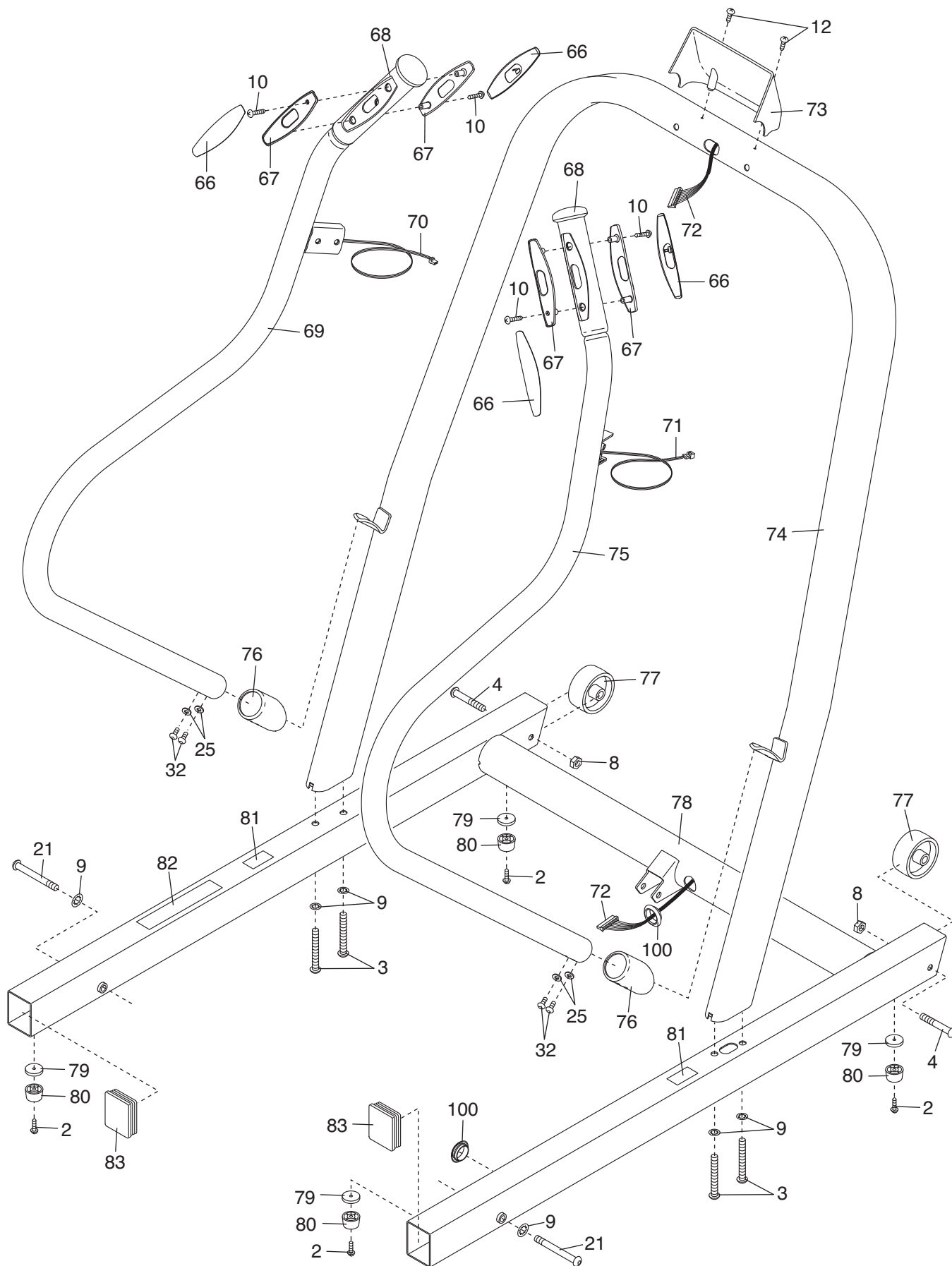

EXPLODED DRAWING D—Model No. SFTL15609.0

R0509A

