

EXPLODED DRAWING A—Model No. SFTL15609.1

R0809A

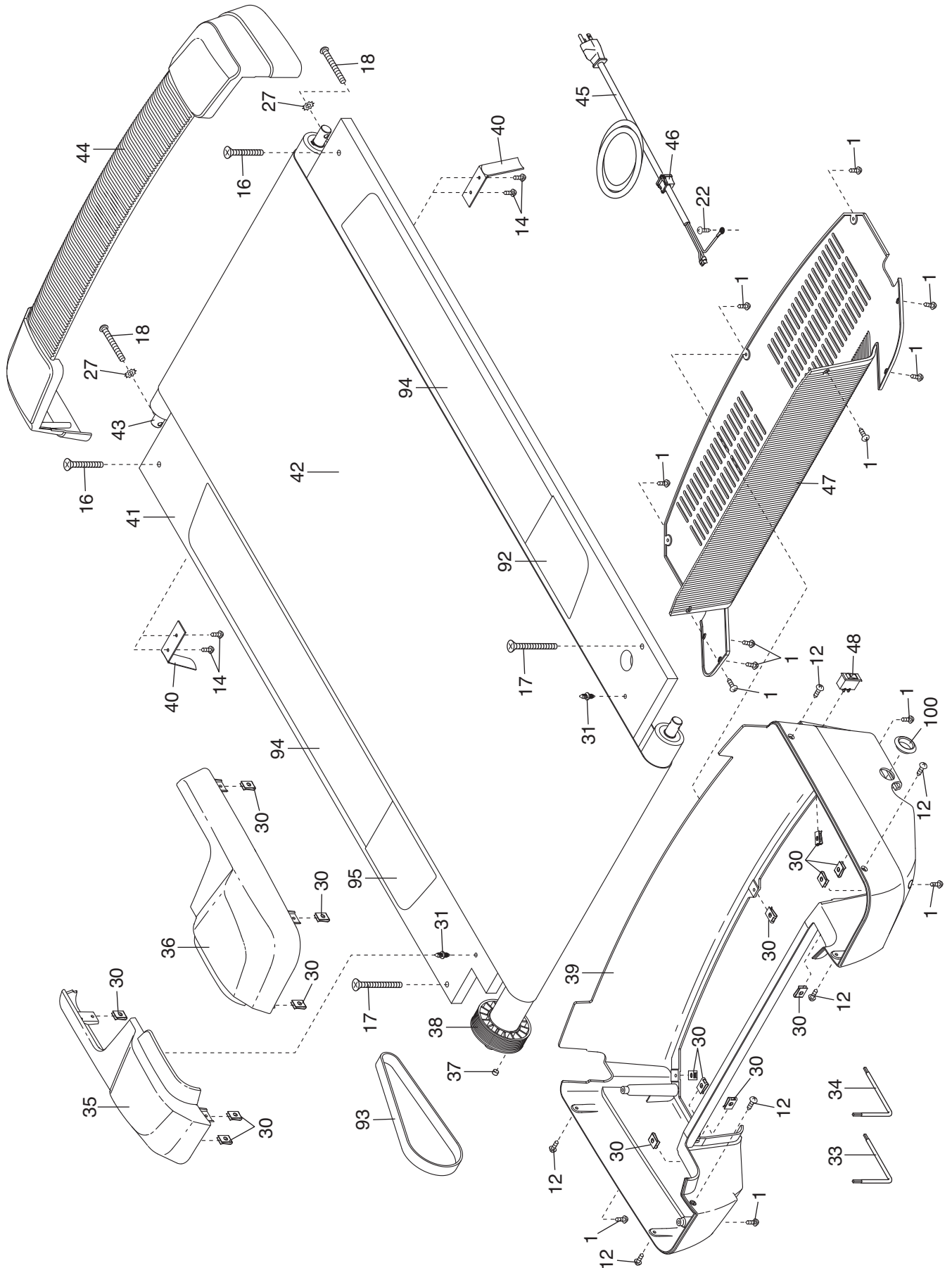

EXPLODED DRAWING B—Model No. SFTL15609.1

R0809A

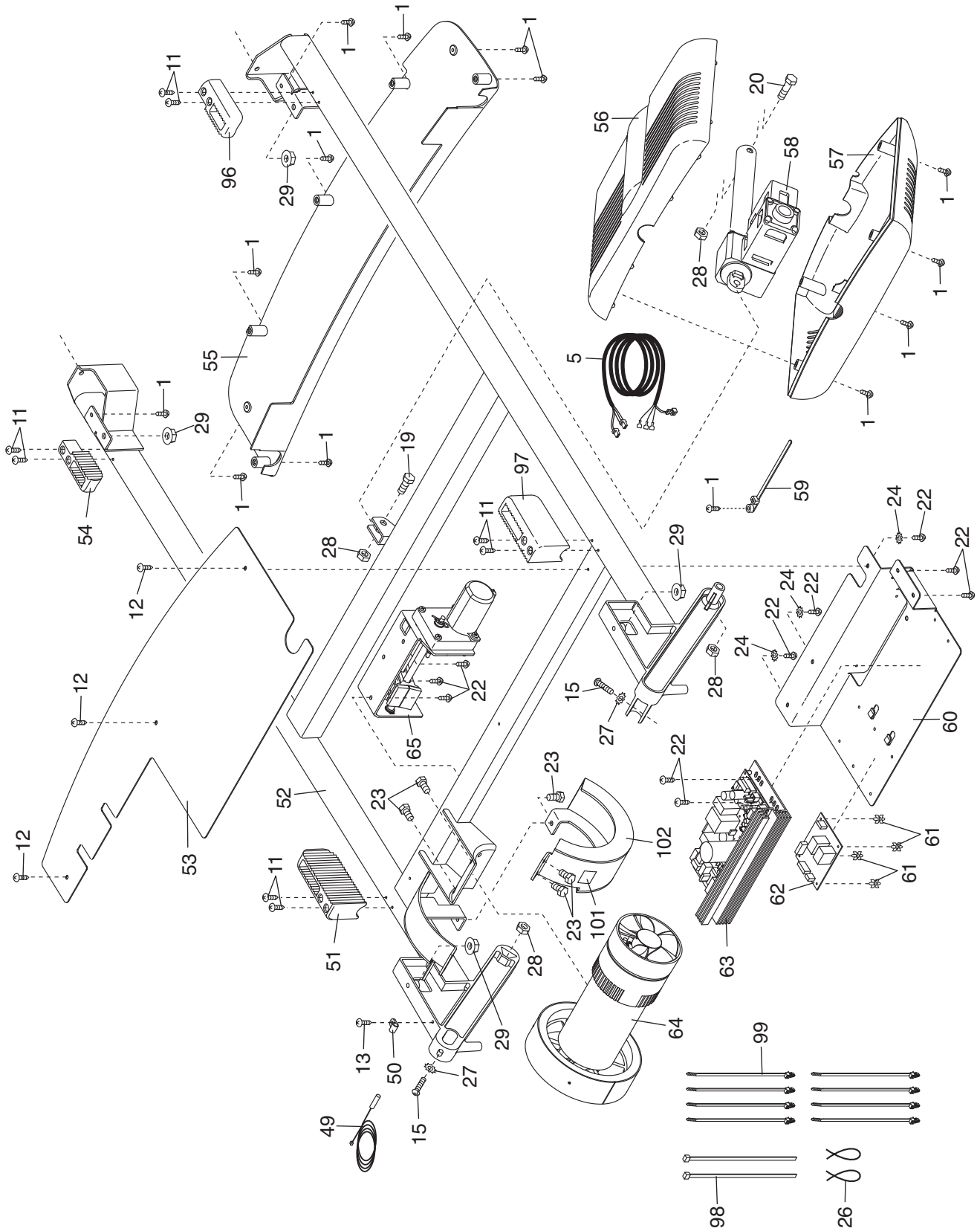

EXPLODED DRAWING C—Model No. SFTL15609.1

R0809A

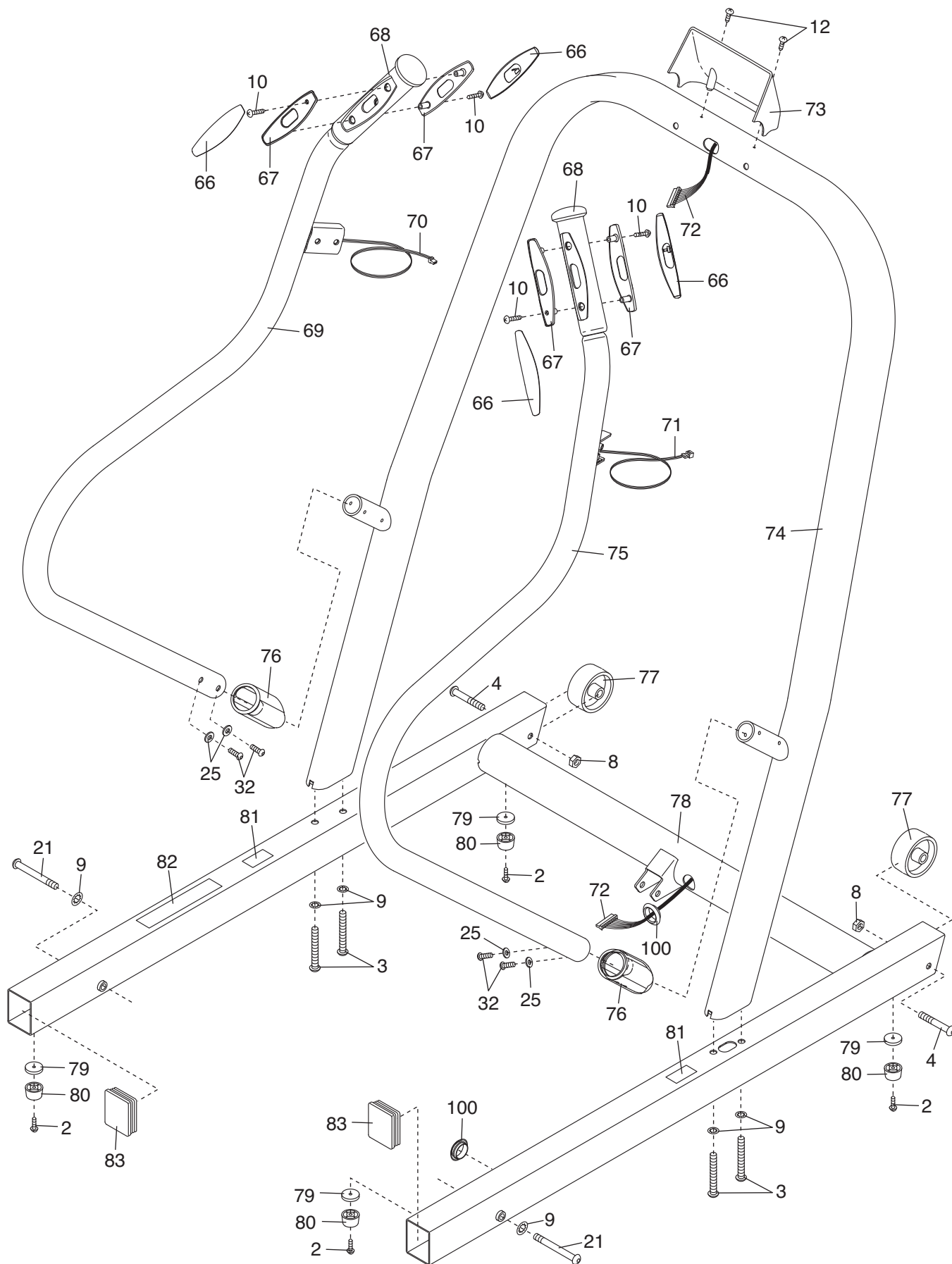

EXPLODED DRAWING D—Model No. SFTL15609.1

R0809A

