

EXPLODED DRAWING A

Model No. SFTL19511.1 R0813A

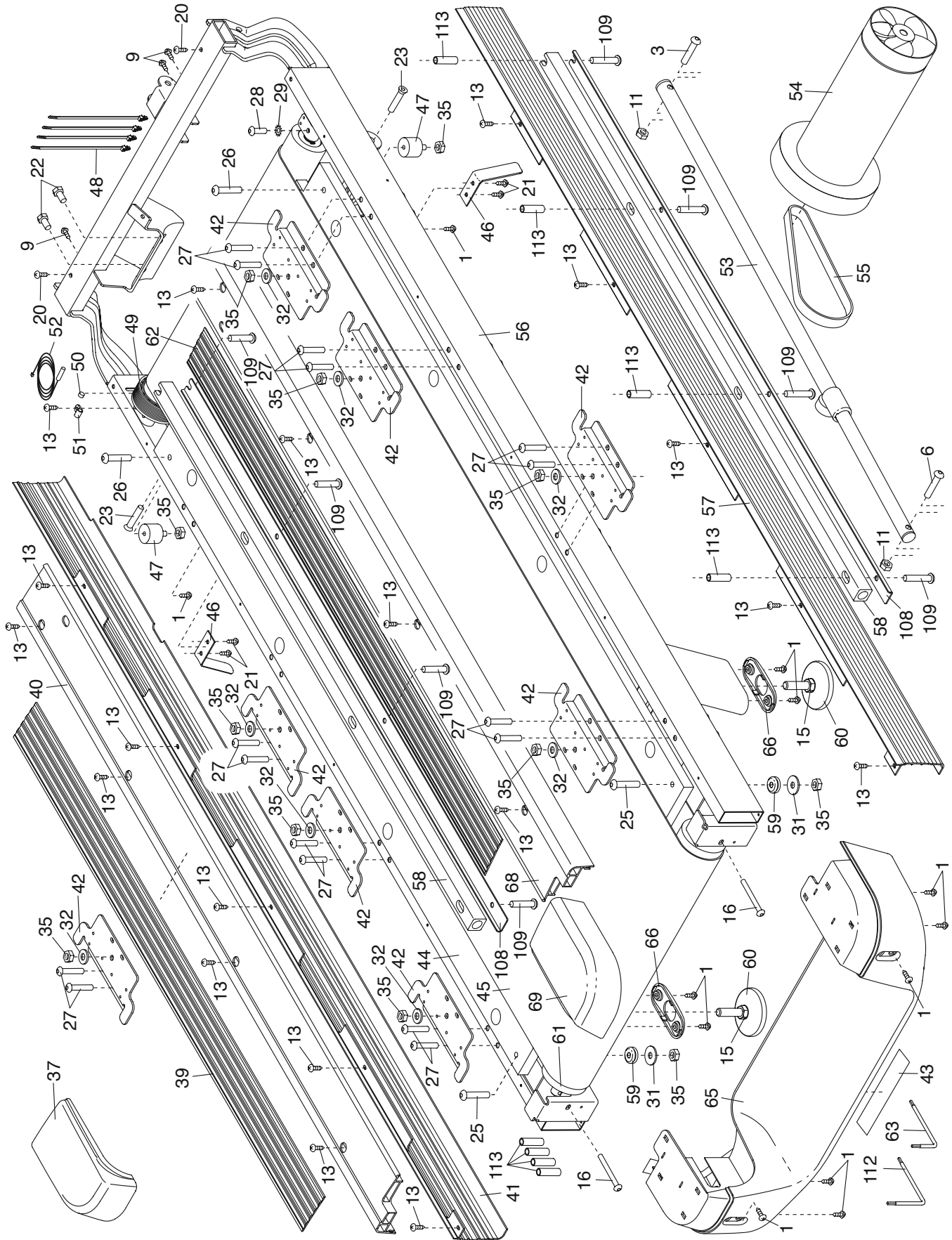

EXPLODED DRAWING B

Model No. SFTL19511.1 R0813A

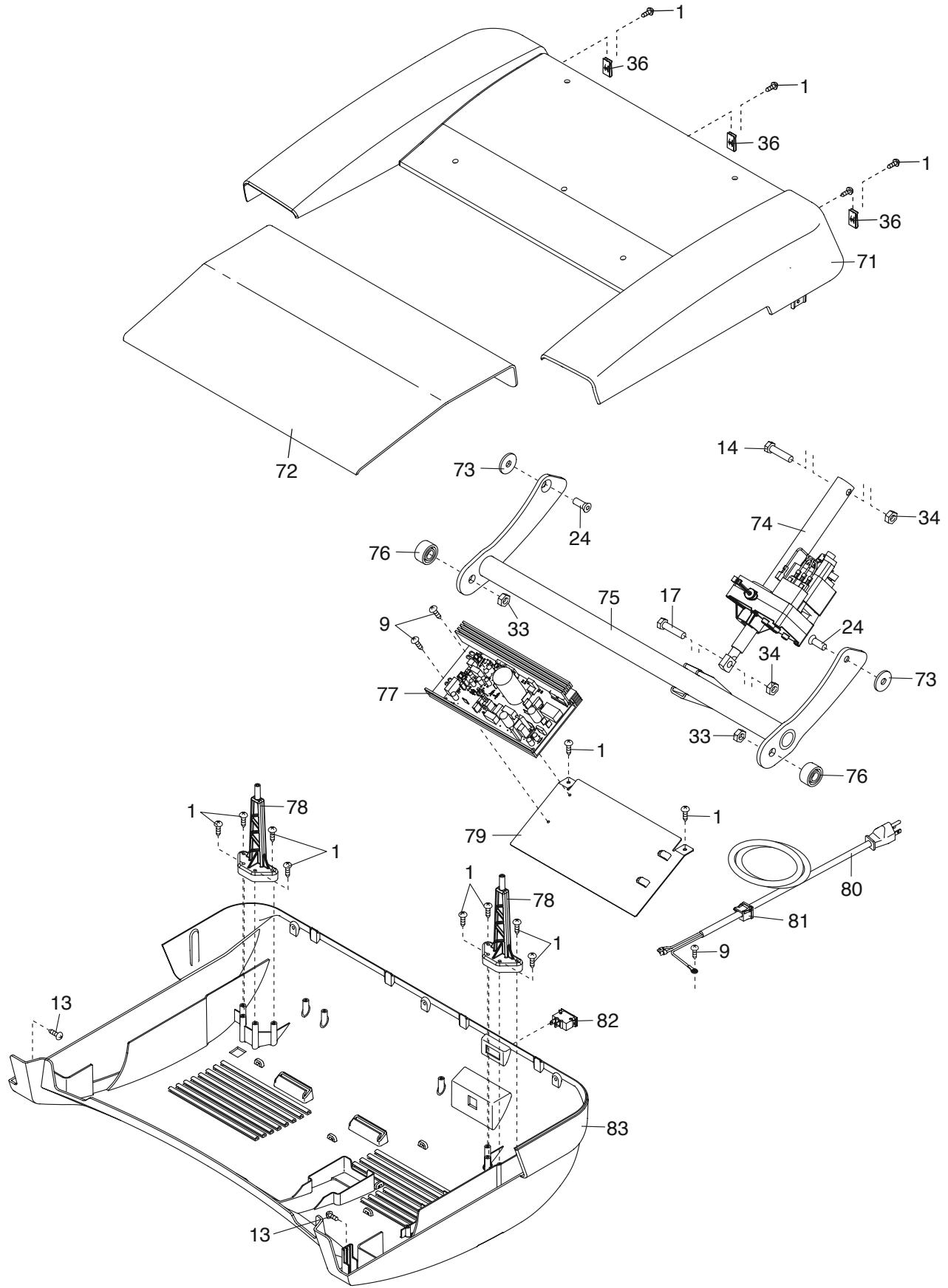

EXPLODED DRAWING C

Model No. SFTL19511.1 R0813A

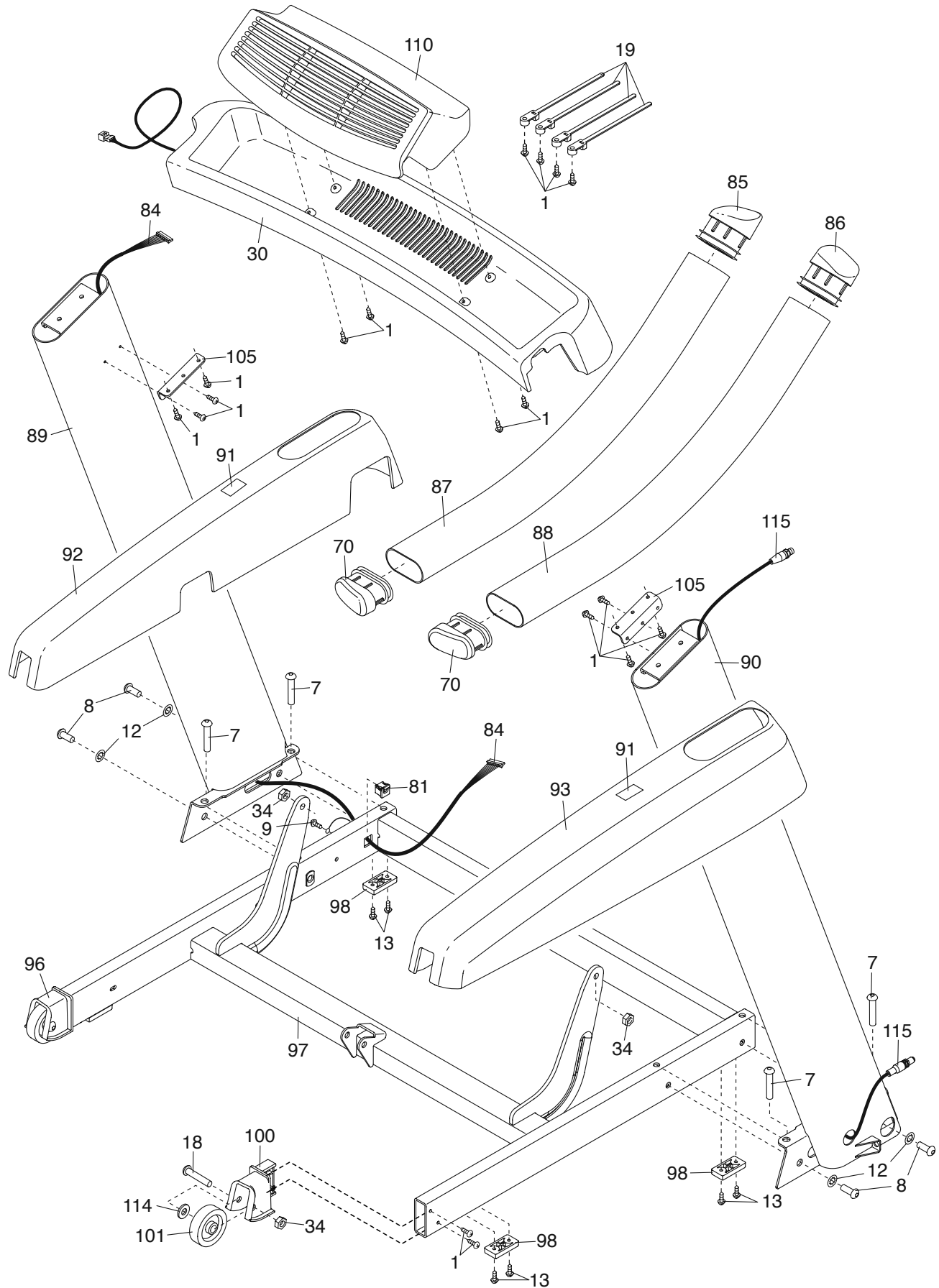

EXPLODED DRAWING D

Model No. SFTL19511.1 R0813A

