

# EXPLODED DRAWING A

Model No. SFTL19513.7 R0916A

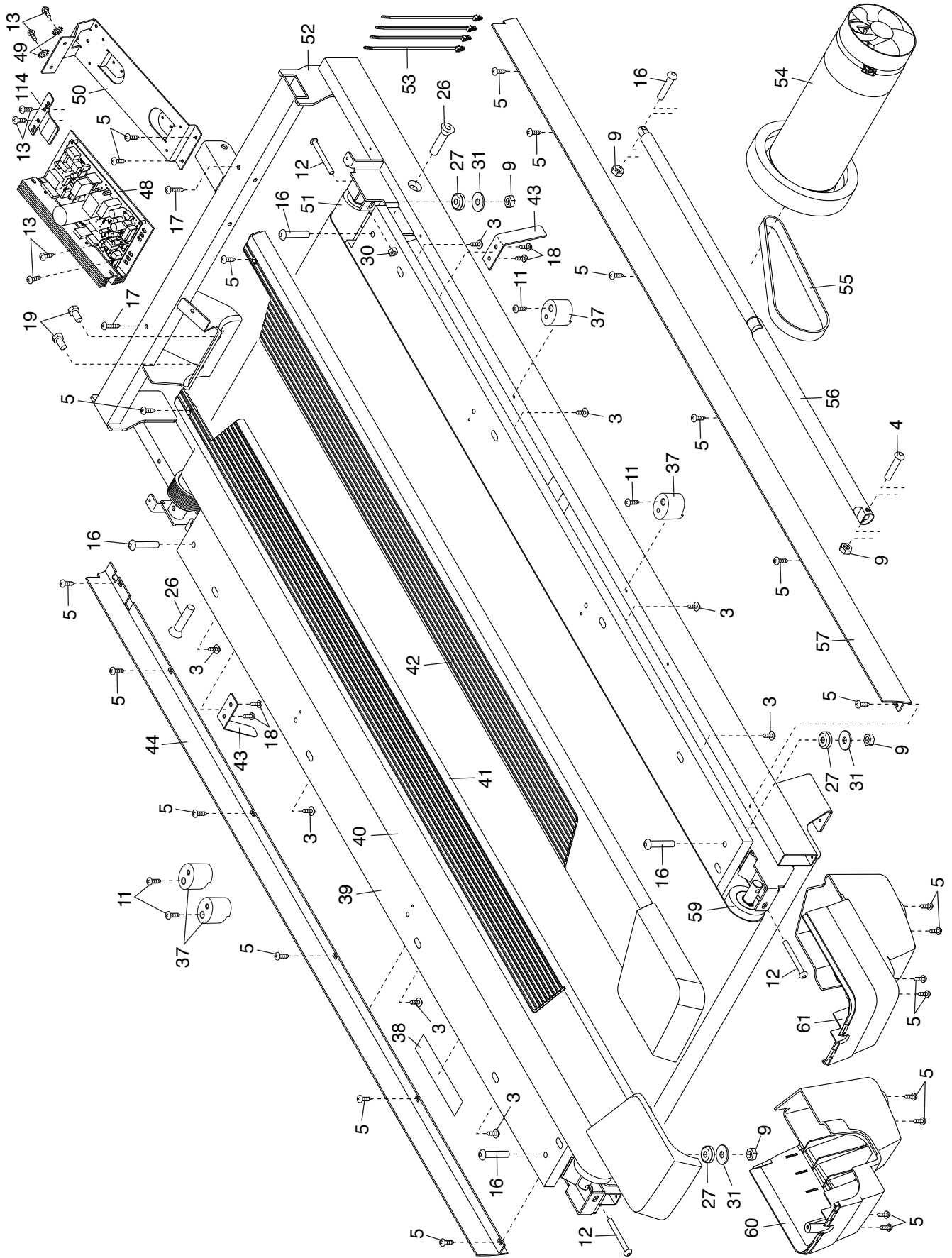

# EXPLODED DRAWING B

Model No. SFTL19513.7 R0916A

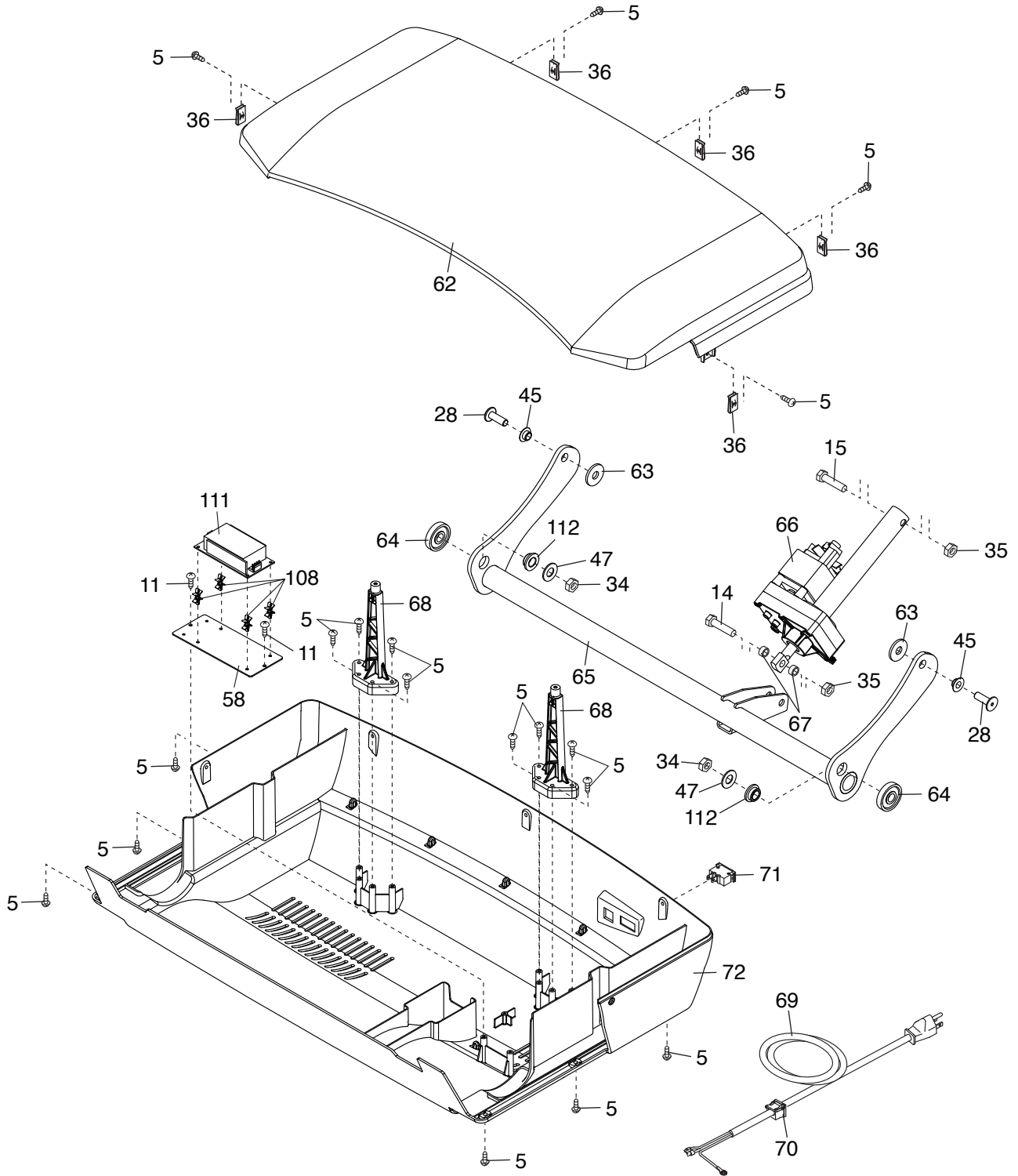

# EXPLODED DRAWING C

Model No. SFTL19513.7 R0916A

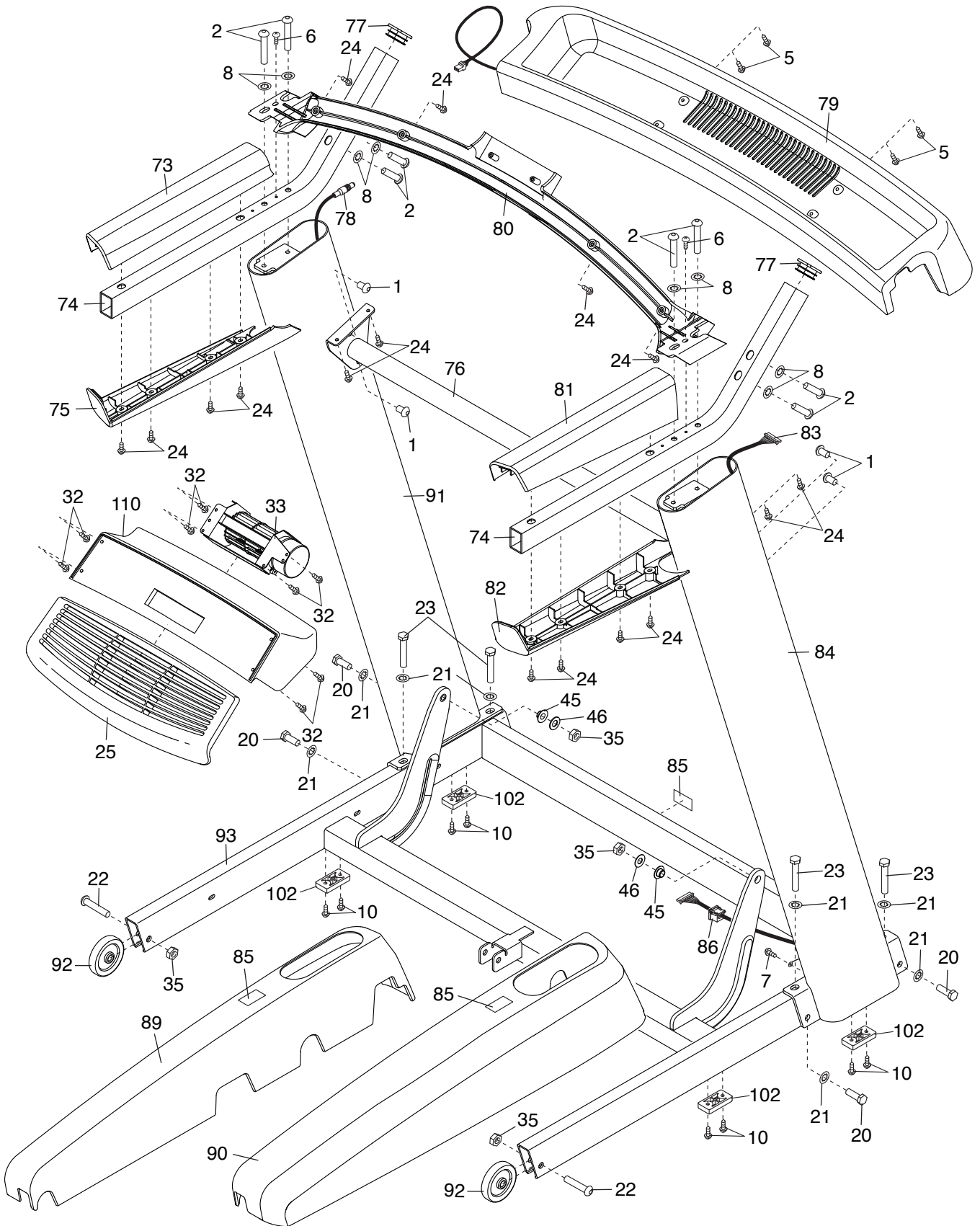

# EXPLODED DRAWING D

Model No. SFTL19513.7 R0916A

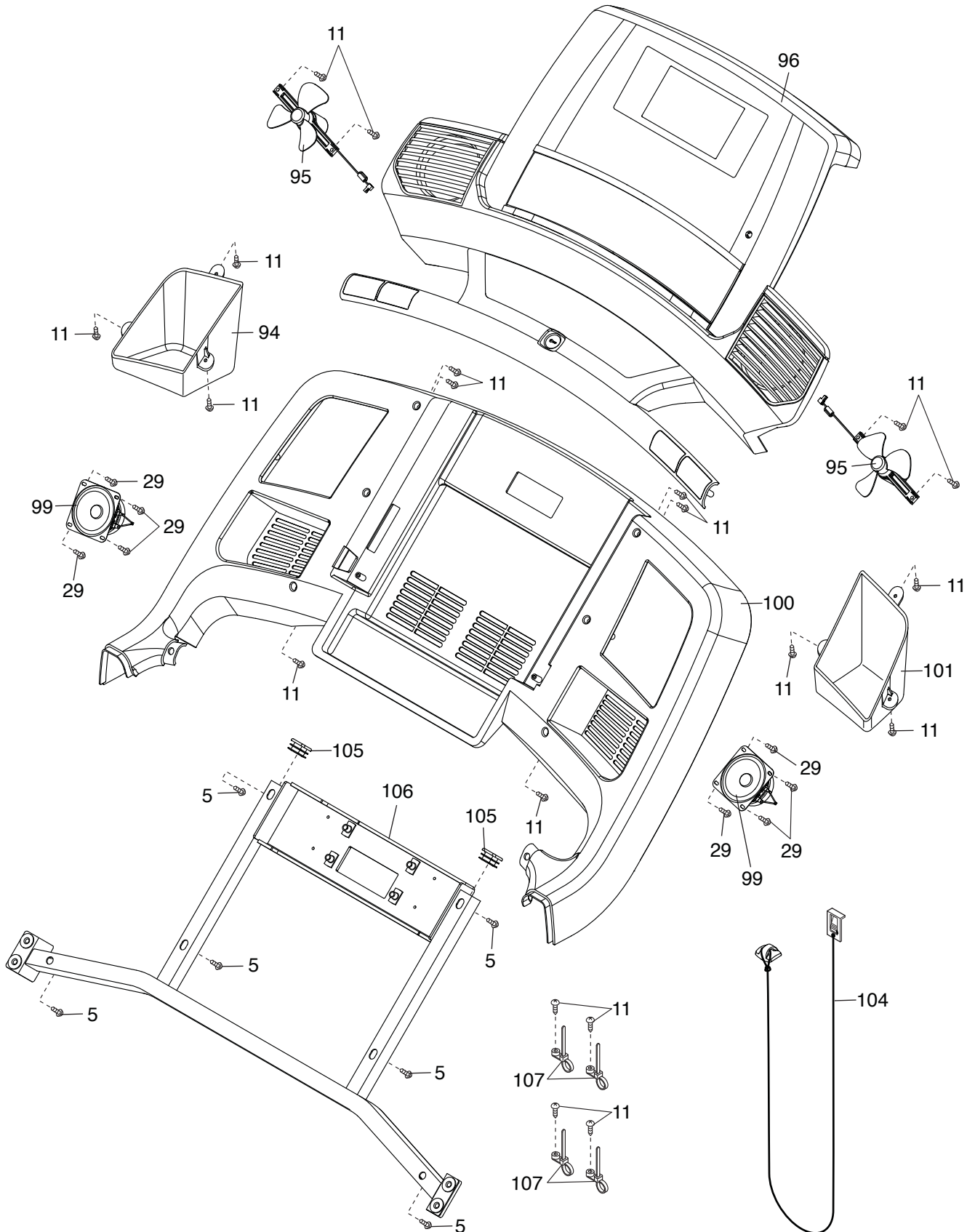

# EXPLODED DRAWING E

Model No. SFTL19513.7 R0916A

