

EXPLODED DRAWING A—Model No. SFTL19909.0

R0510A

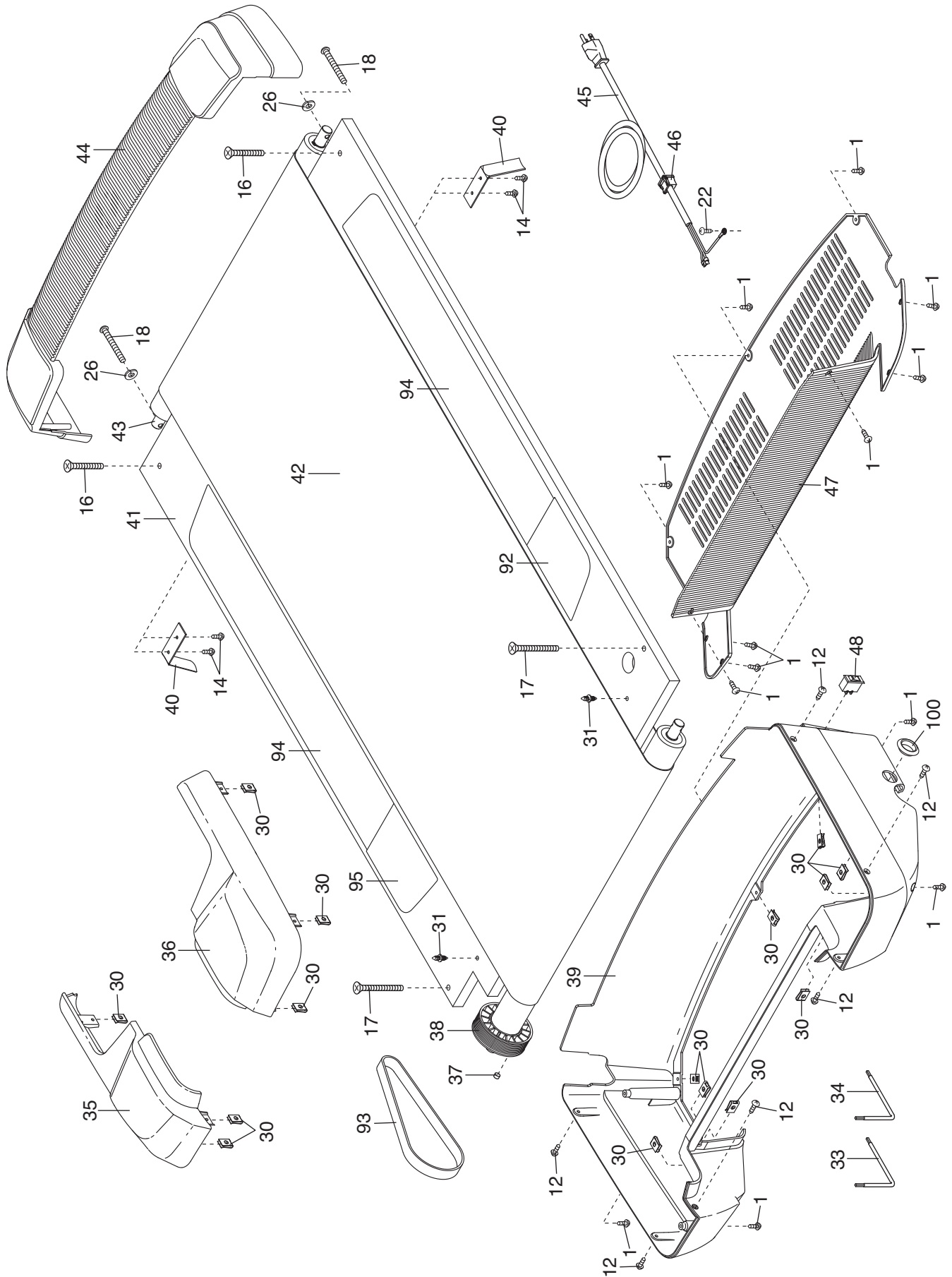

EXPLODED DRAWING B—Model No. SFTL19909.0

R0510A

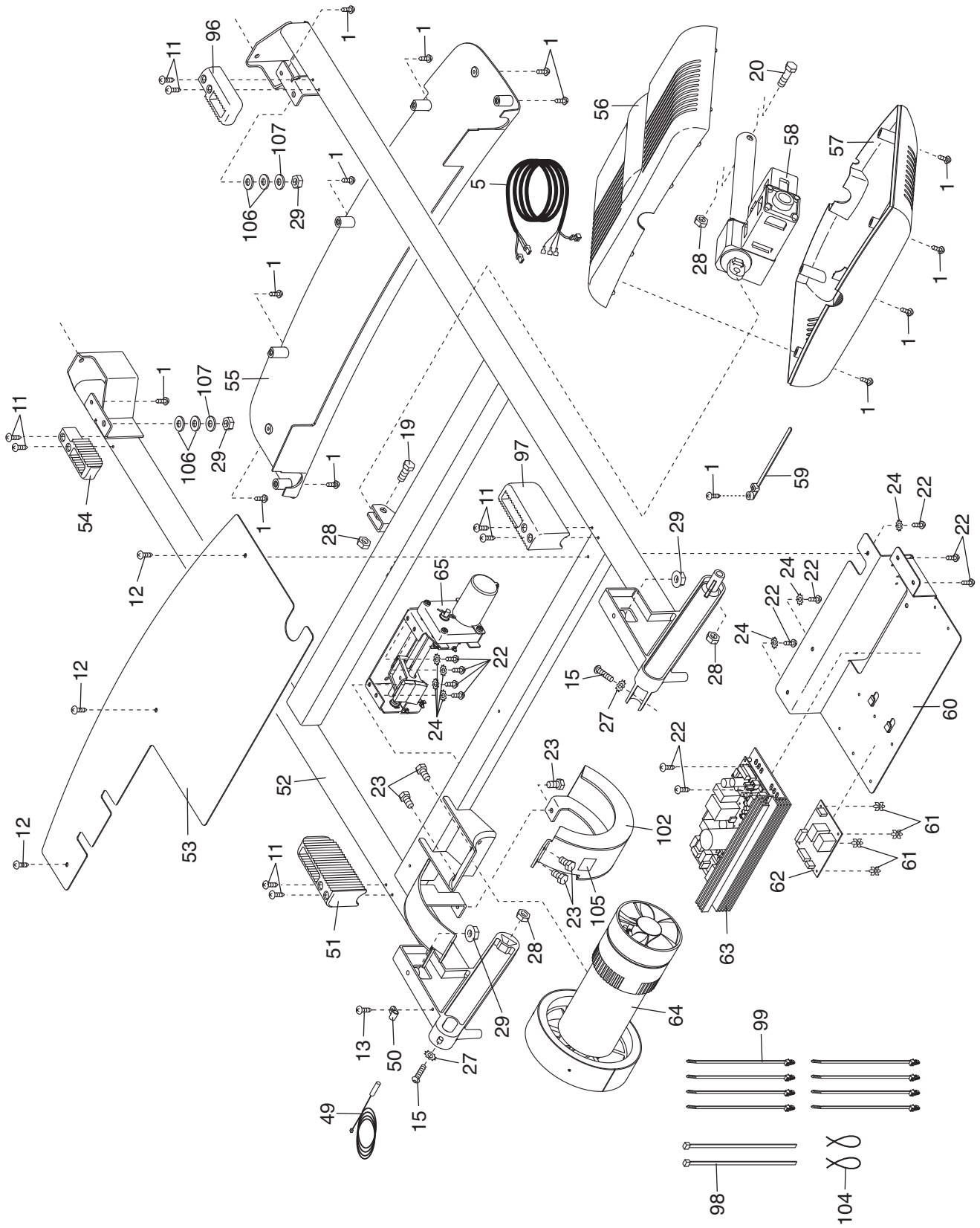

EXPLODED DRAWING C—Model No. SFTL19909.0

R0510A

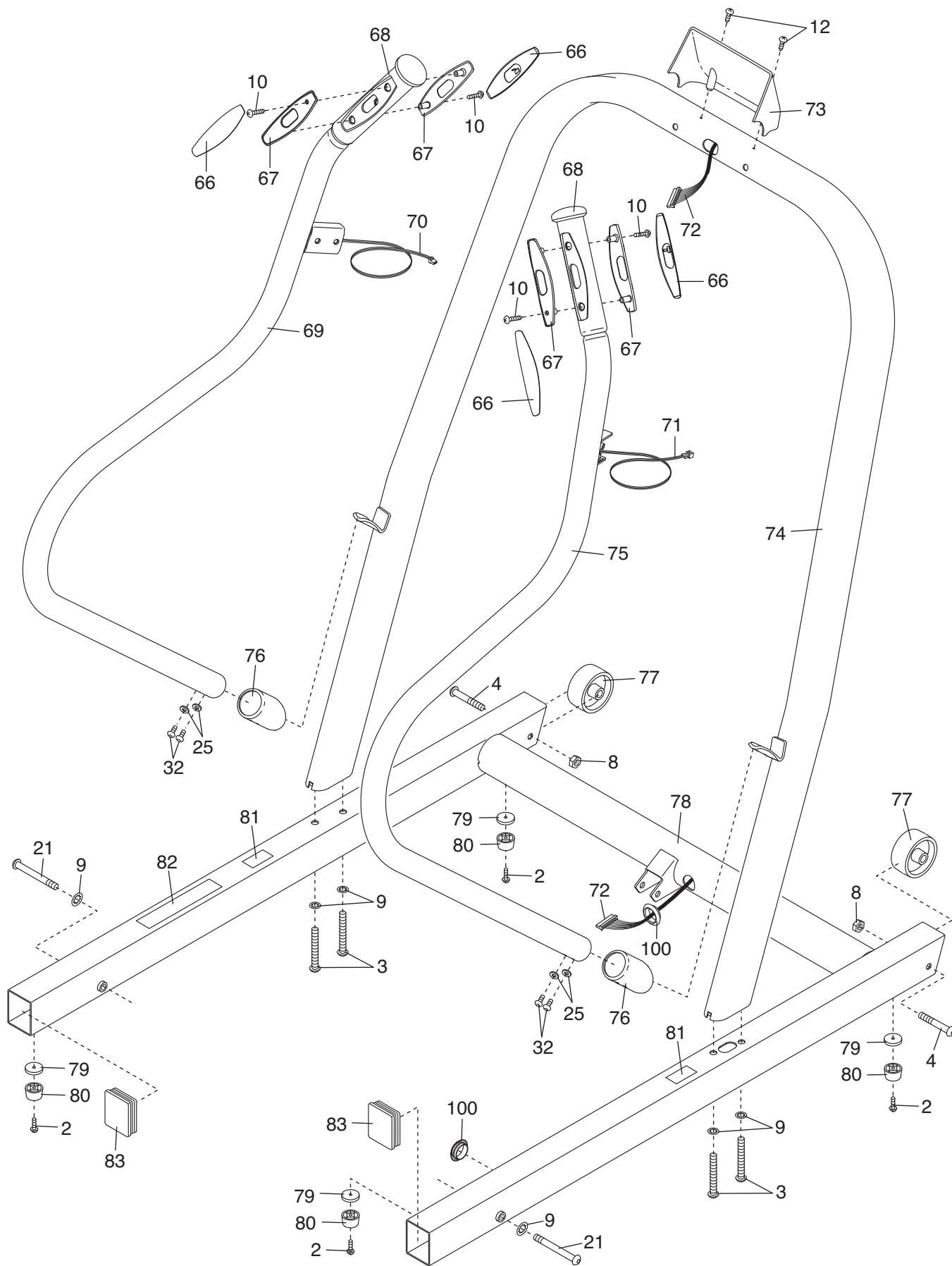

EXPLODED DRAWING D—Model No. SFTL19909.0

R0510A

