

# EXPLODED DRAWING A

Model No. SFTL20512.0 R1212A

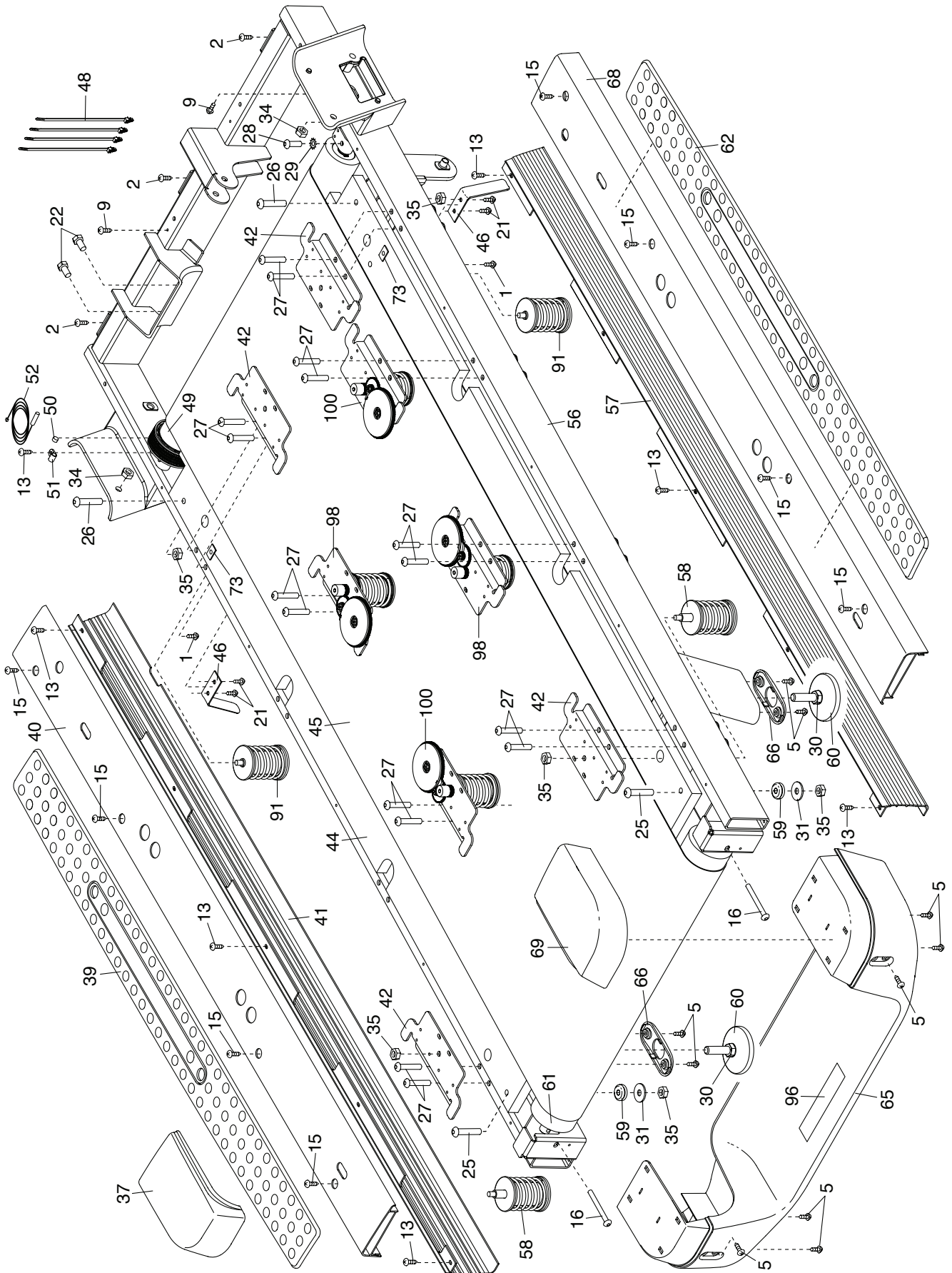

# EXPLODED DRAWING B

Model No. SFTL20512.0 R1212A

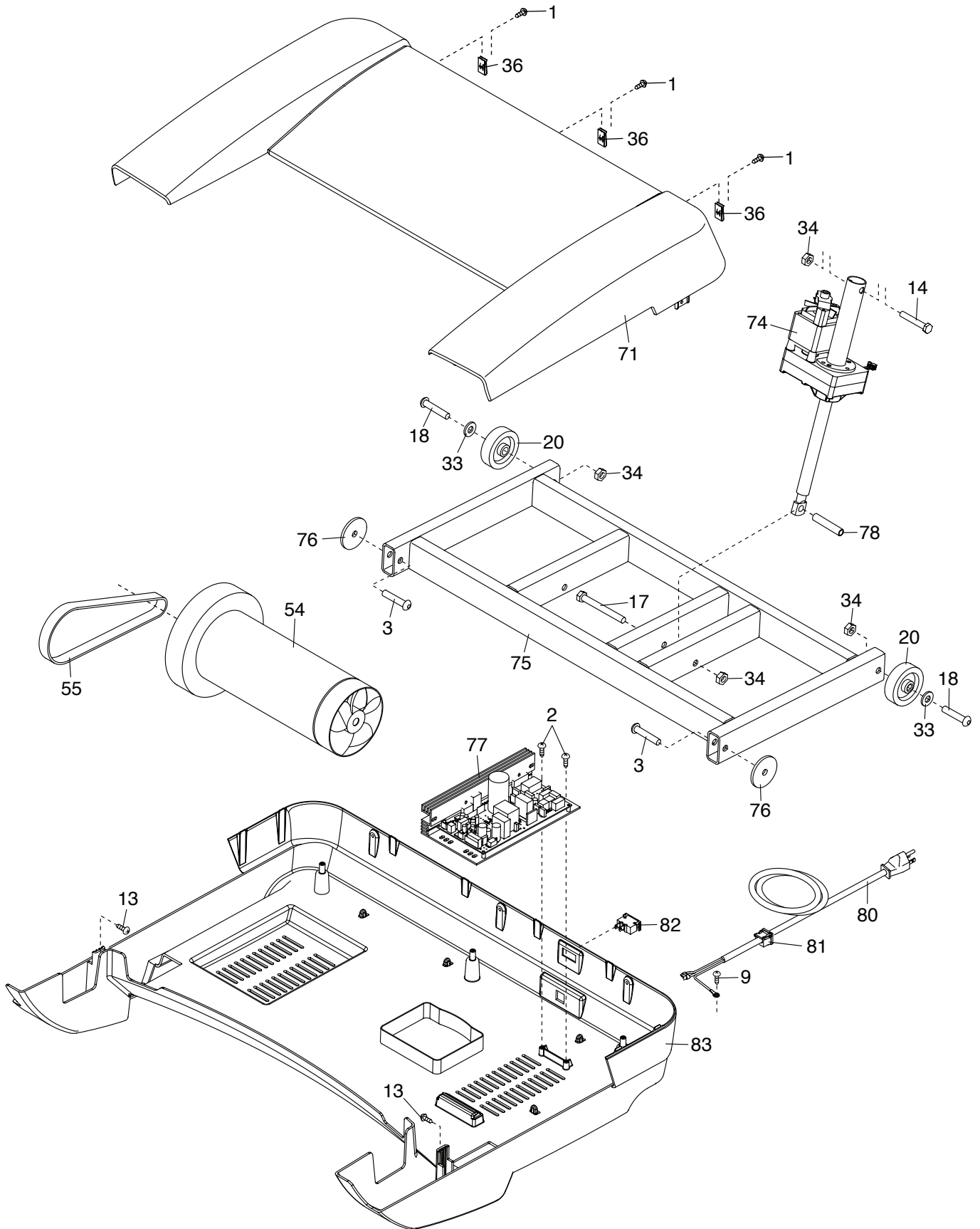

# EXPLODED DRAWING C

Model No. SFTL20512.0 R1212A

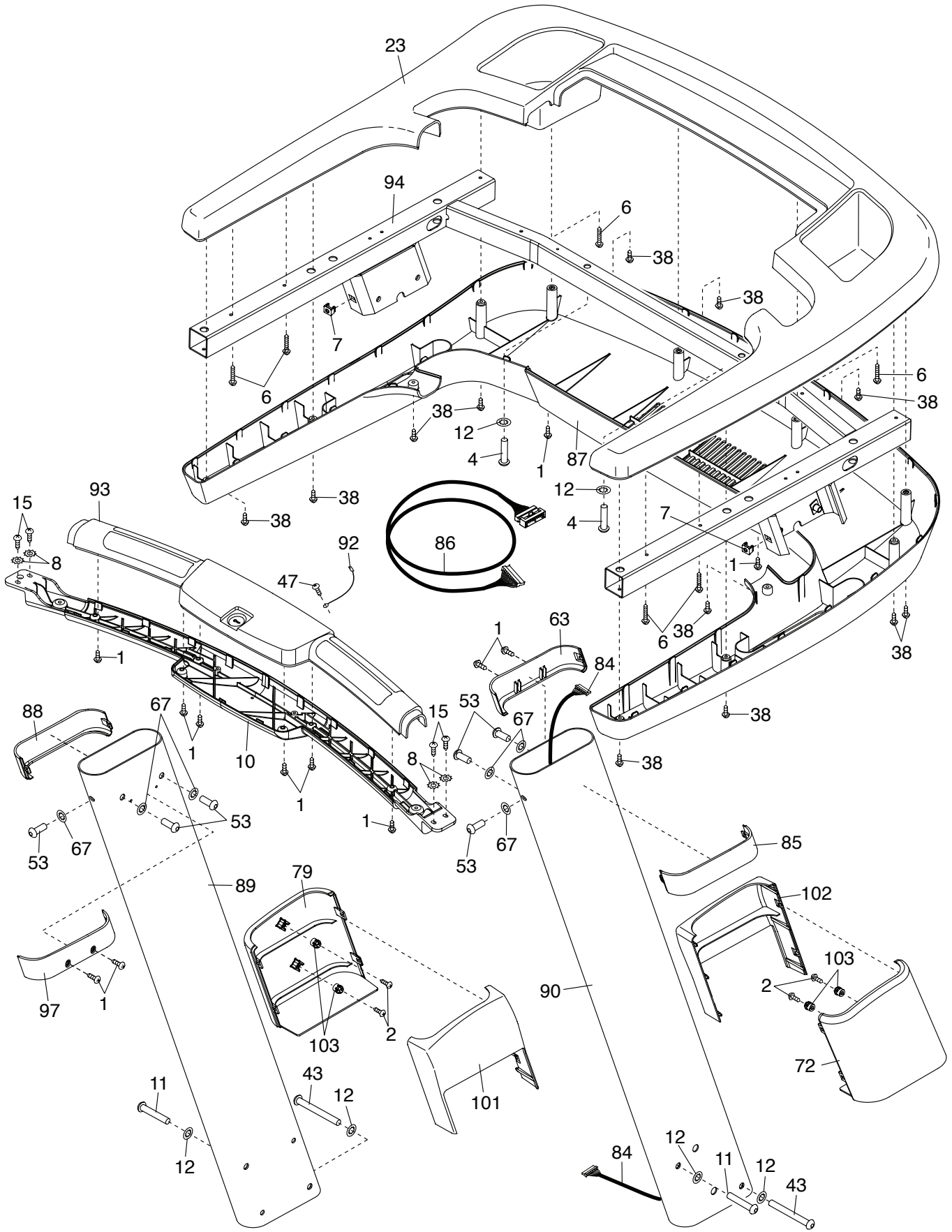

# EXPLODED DRAWING D

Model No. SFTL20512.0 R1212A

