

EXPLODED DRAWING A

Model No. SFTL20512.1 R1013A

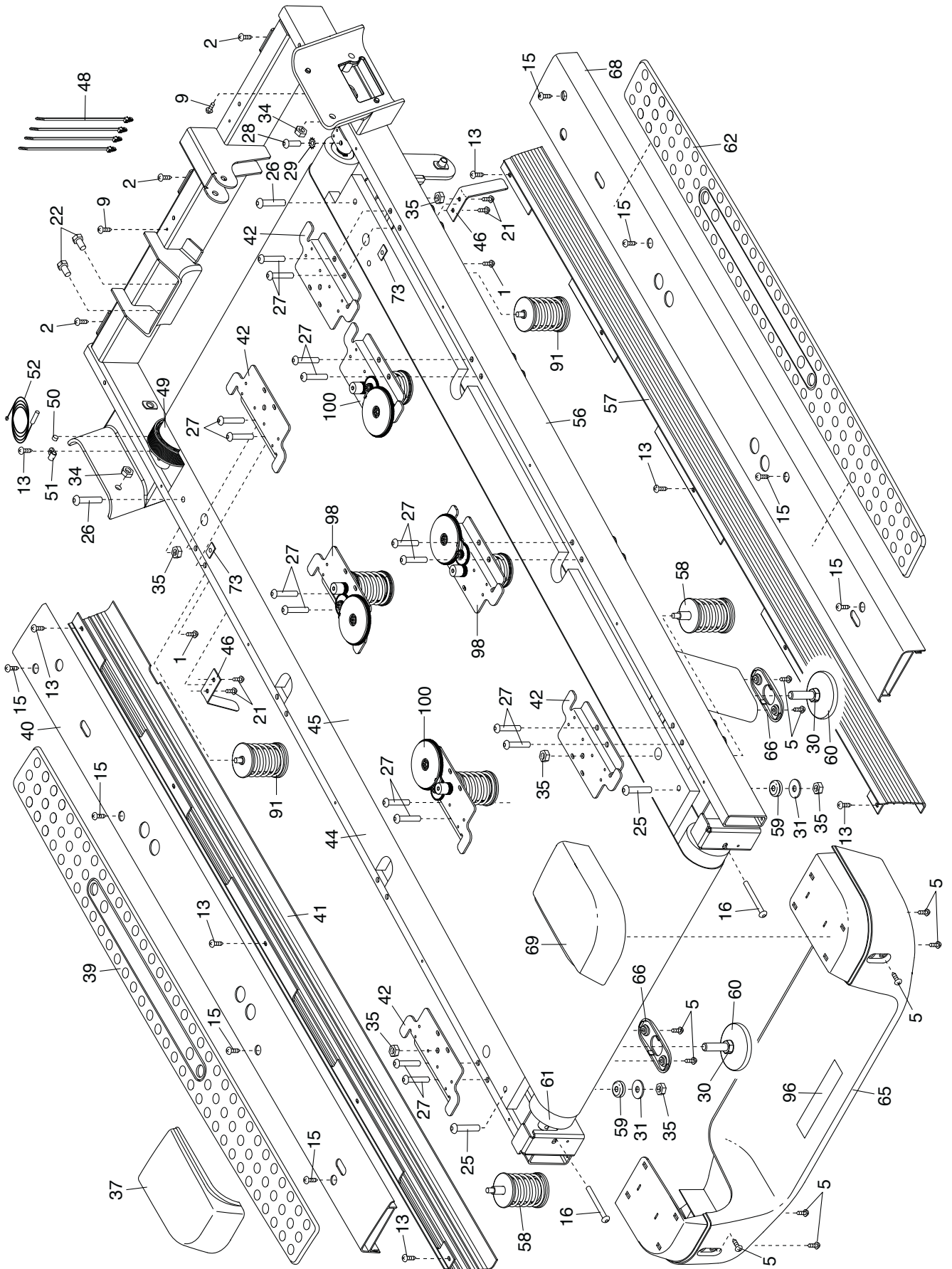

EXPLODED DRAWING B

Model No. SFTL20512.1 R1013A

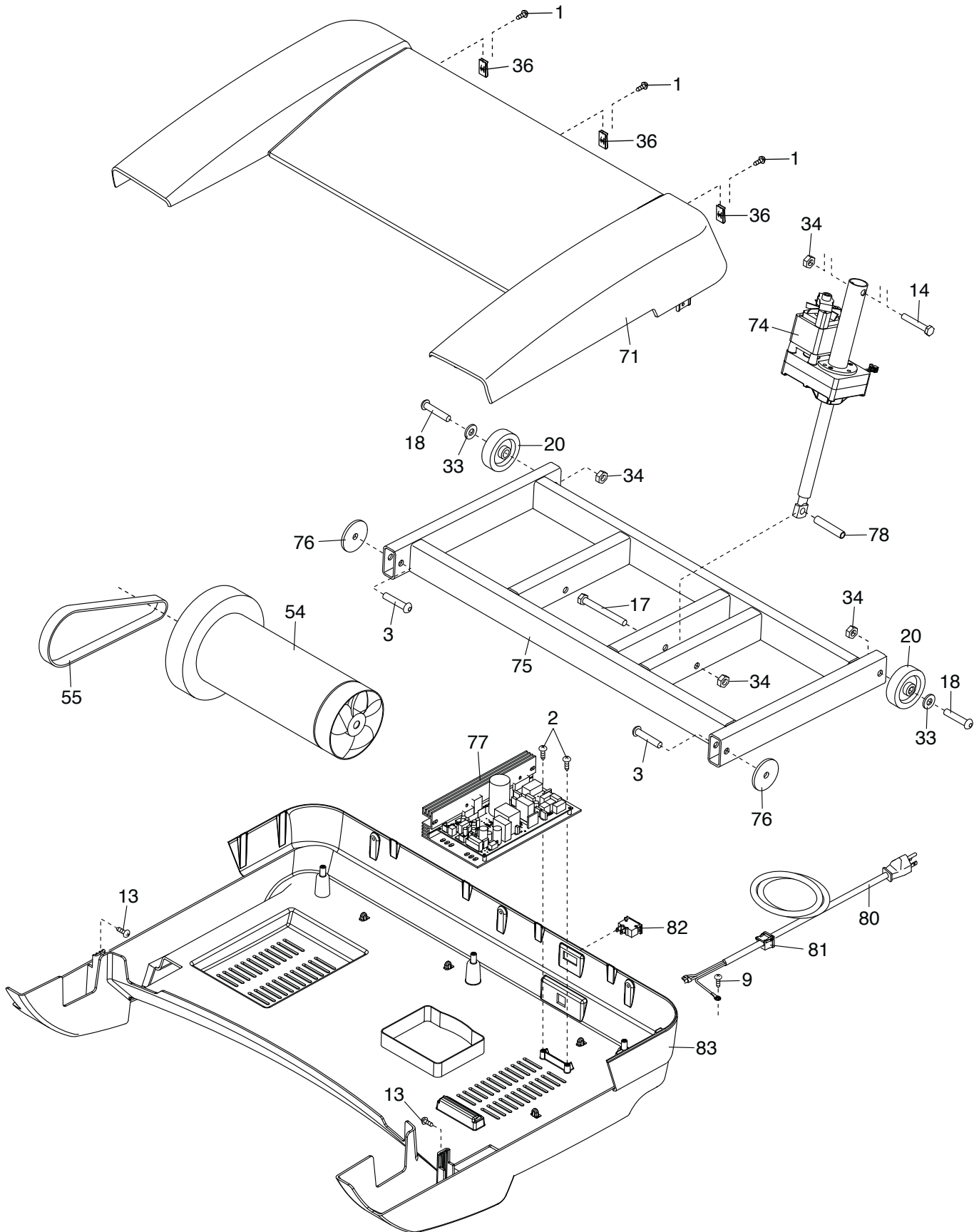

EXPLODED DRAWING C

Model No. SFTL20512.1 R1013A

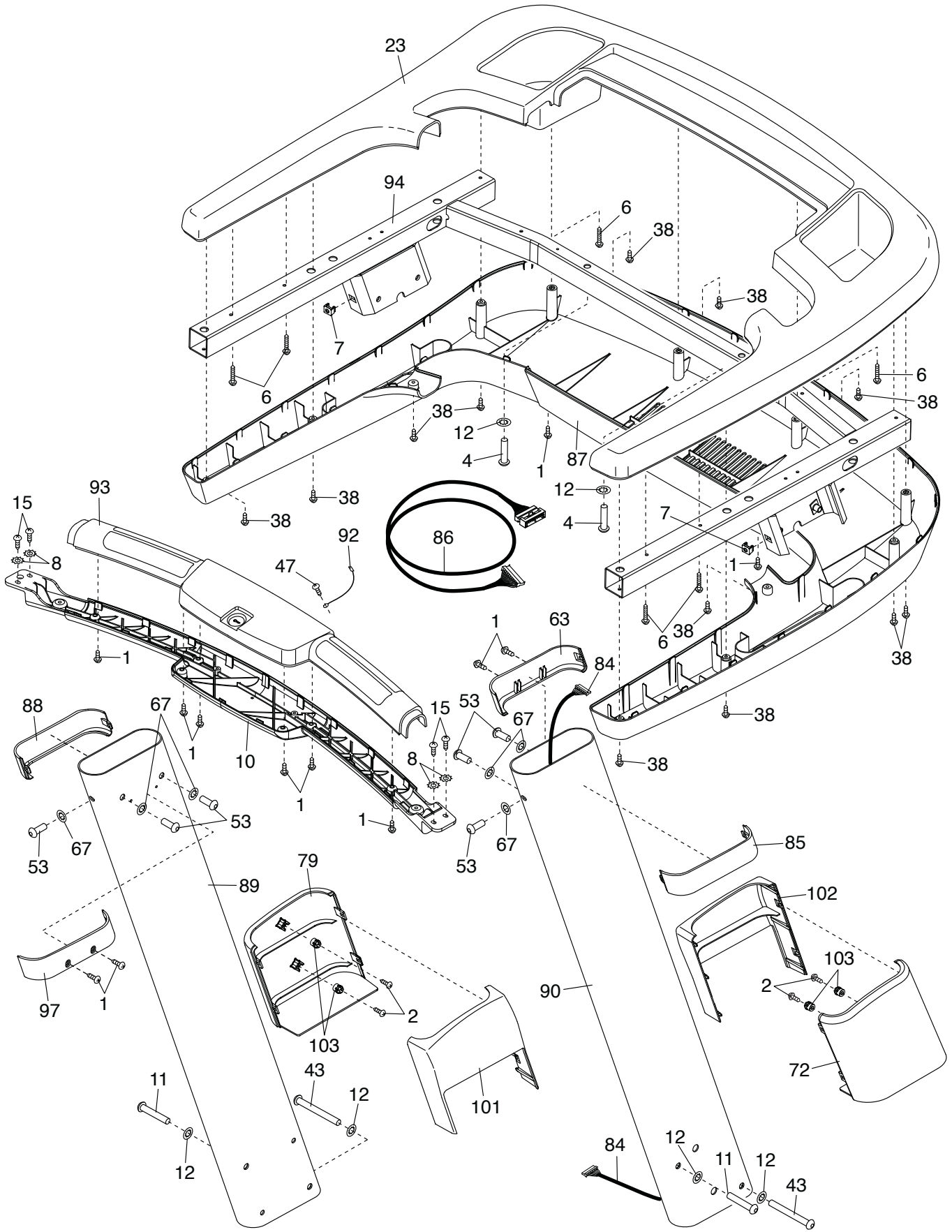

EXPLODED DRAWING D

Model No. SFTL20512.1 R1013A

